

2. FEATURES

1. Noise has been reduced to the minimum and S/N (Signal-to-Noise) ratio has been further improved by the adoption of Hitachi's high-performance, low-noise type hybrid IC (Integrated Circuits) in the equalizer section.
2. Since the tone control uses the NF type step-system, clear tone effect can be enjoyed.
3. Complementary ITL, OTL circuits of constant current drive system and Hitachi high-performance silicone transistors have realized the lowest distortion and minimum noise.
4. Since an amplifier for the exclusive use of a microphone is built-in, mixing with other program source is possible. Therefore, this model is very convenient for singing songs with background of some records or commenting on record concerts.
5. This amplifier can be used without any input transformer, because the head amplifier for MC (Moving Coil) type cartridge has been installed in the amplifier.
6. It is possible to use this model for various purposes, because the IA-1000 is equipped with a pre-main detachable terminal.
7. Using the center-channel output terminal makes it possible to utilize this model as a center woofer system.
8. An electronic protection circuit is adopted for safety use.
9. The one-touch system of speaker connection terminal makes speaker connection easier.
10. The VU meter built-in is convenient for output and balance ascertainment.

3. FRONT AND REAR PANEL

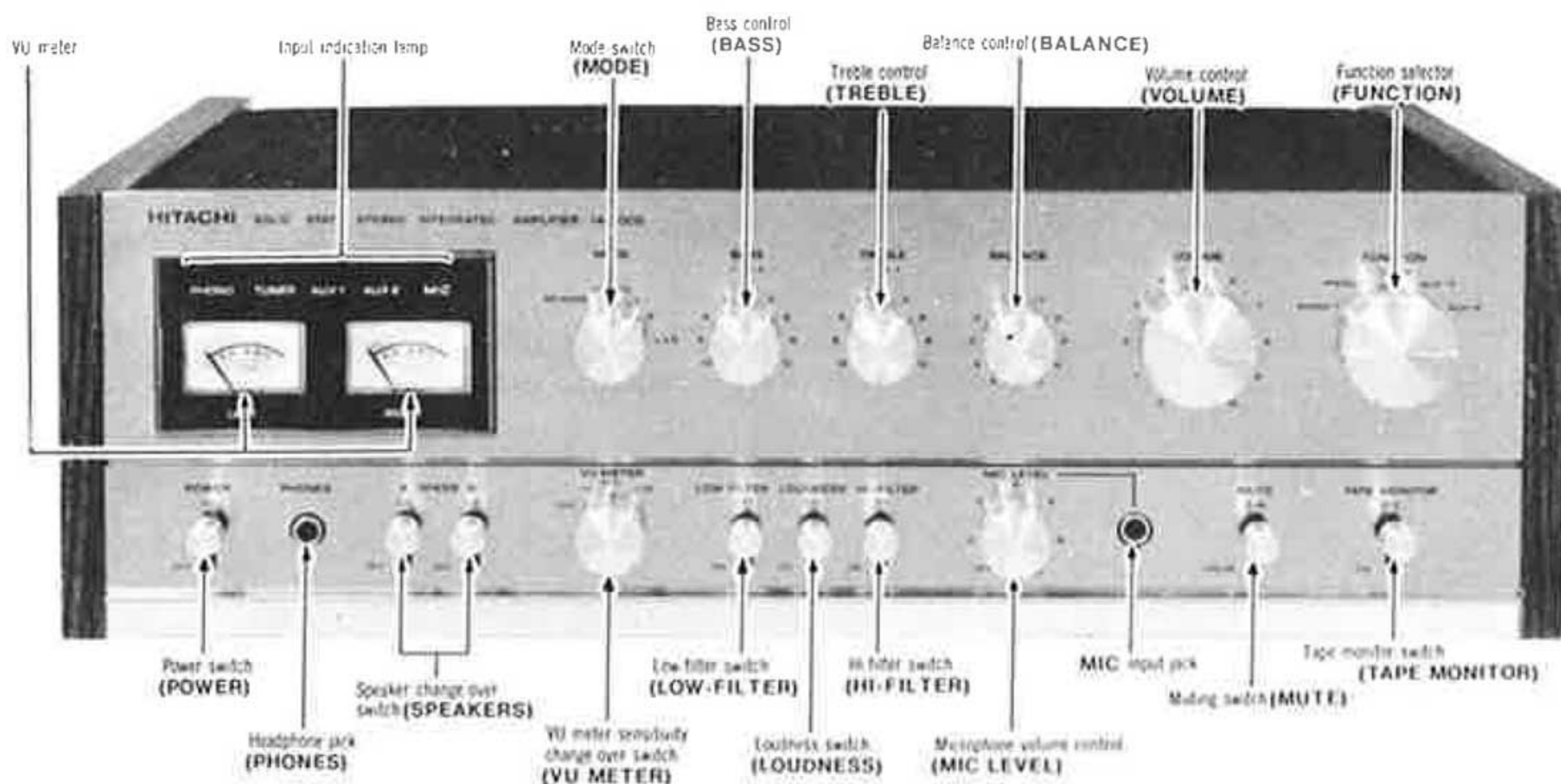

Fig. 1 FRONT PANEL

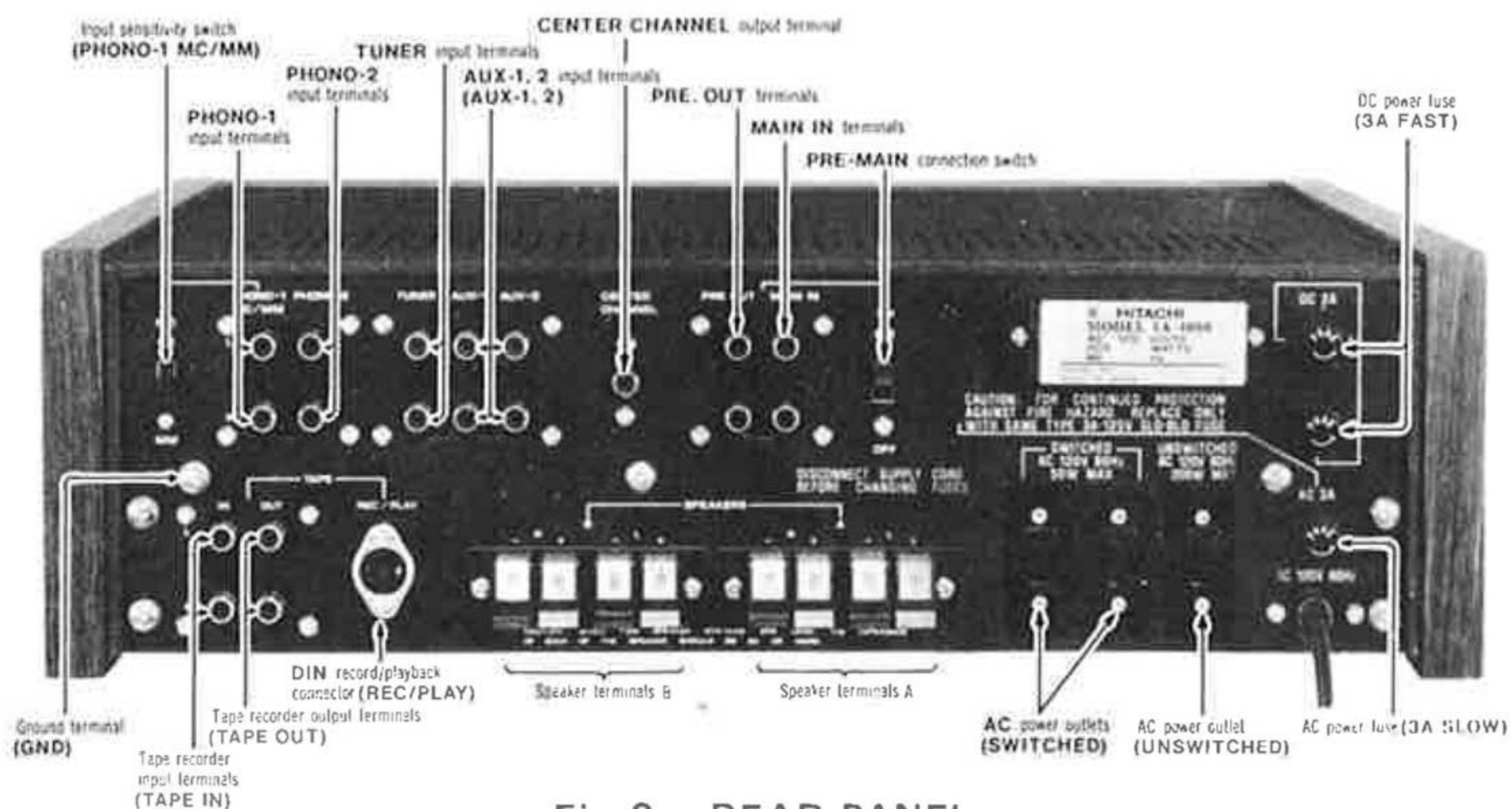

Fig. 2 REAR PANEL

4. SERVICE POINT

4-1 How to inspect the IC circuitry

The hybrid type IC adopted in this model is for an amplification of small signal.

The inside circuitry is, as shown in the circuit diagram on page 13, the same as the 2-stage amplification of an ordinary transistor.

At the time of servicing a set, we can find out damaged IC, as we always do on ordinary transistors, by inspecting each voltage of collector, emitter and base.

The following list shows the standard voltage value of each terminal at the time when IC operates normally.

In case that each terminal voltage value is remarkably different from each standard voltage value, we can consider that the IC has undergone some damage.

In this case, it is recommended to replace it with a new one.

The standard voltage in the following list have been measured by the use of a VTVM (Vacuum Tube Volt Meter) which has higher input impedance. If a tester is used to measure each voltage, values a little lower than these can be obtained.

IC TERMINAL NO. (The same as the seal No. on the Printed Circuit Board)		STANDARD VOLTAGE VALUE
①	1st stage collector voltage	2.4V
② INPUT TERMINAL	1st stage base voltage	0.85V
③	1st stage emitter voltage	0.23V
④ GROUND LEAD TERMINAL		0V
⑤	2nd stage emitter voltage	1.7V
⑥ OUTPUT TERMINAL	2nd stage collector voltage	14.0V
⑦ + POWER SOURCE TERMINAL		25.0V

4-2 Adjustment of Current

1. Adjustment of current can be made in the manner identical to conventional method. It will be convenient to use the fuse holder terminals for DC ammeter.

That is, remove the fuse and connect the DC ammeter between terminals of fuse holder. (See Fig. 3)

2. Then adjust the semi-fixed resistor (VR702) so that the DC ammeter indicates 30mA.

3. Make this adjustment when the meter indication is stabilized about 5 minutes after the switch is turned on.

4-3 Adjustment of Voltage at Intermediate Point

1. Connect positive (+) side of the DC voltmeter to positive (+) side of electrolytic capacitor C7, and connect negative (–) side of the DC voltmeter to chassis. (See Fig. 3)

2. Adjust the semi-fixed resistor (VR701) so that the DC voltmeter indicates 37V.

4-4 Adjustment of Left-and-Right Balance of VU Meter (See Fig. 4)

1. Set the semi-fixed resistor (VR4) at about the center.
2. Turn the VU meter sensitivity change-over switch to "LOW" position and set the mode switch to "L + R" position.
3. Place the function selector at "TUNER" position, and add sine wave of 1 kHz to the input terminal of the tuner by the oscillator.
4. Turn up the volume to maximum level and adjust the output voltage of the oscillator so that both VU meters indicate about 100%.
5. Adjust the semi-fixed resistor (VR4) so that pointers of both VU meters deviate to the identical extent.

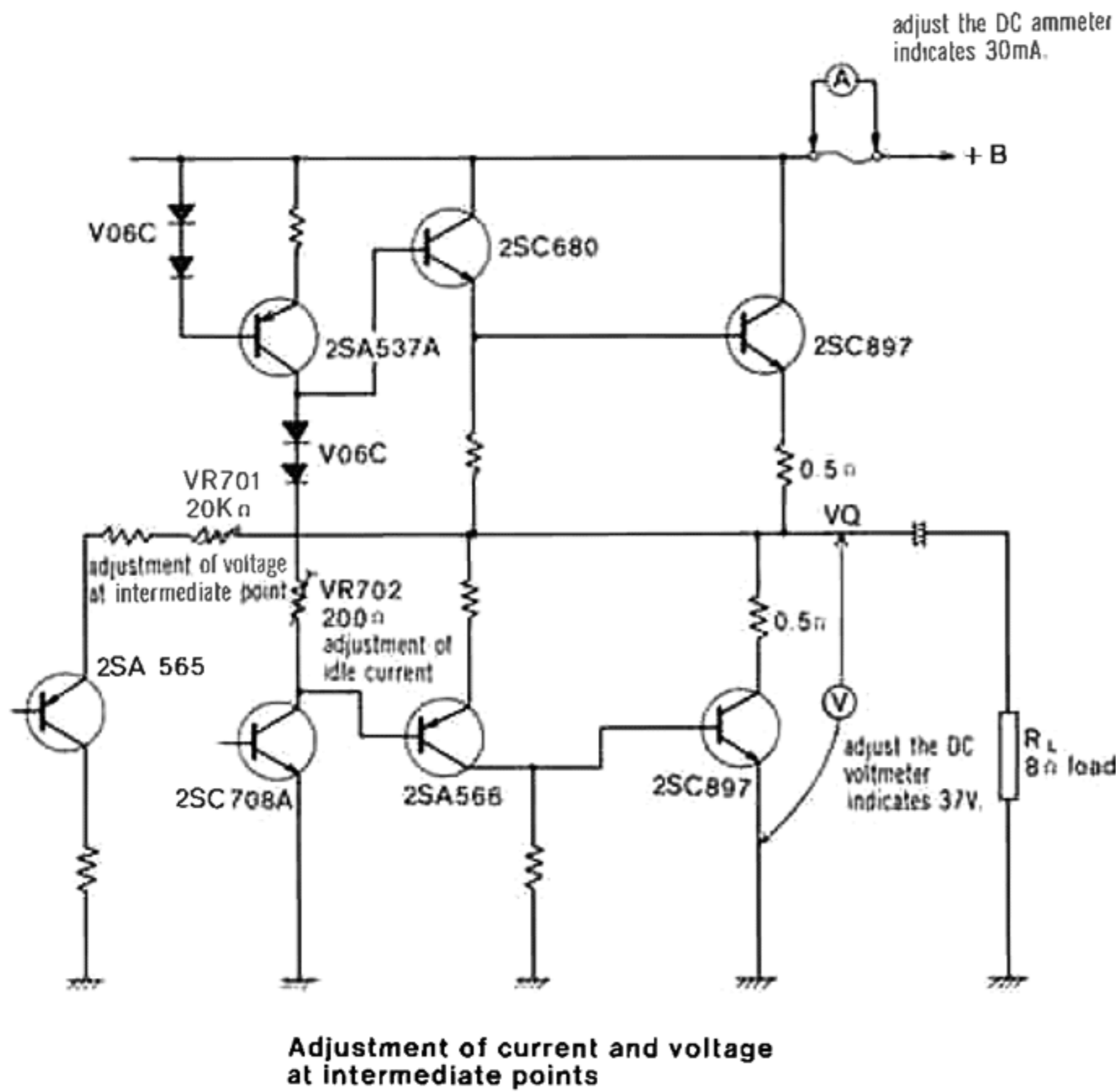

Fig. 3

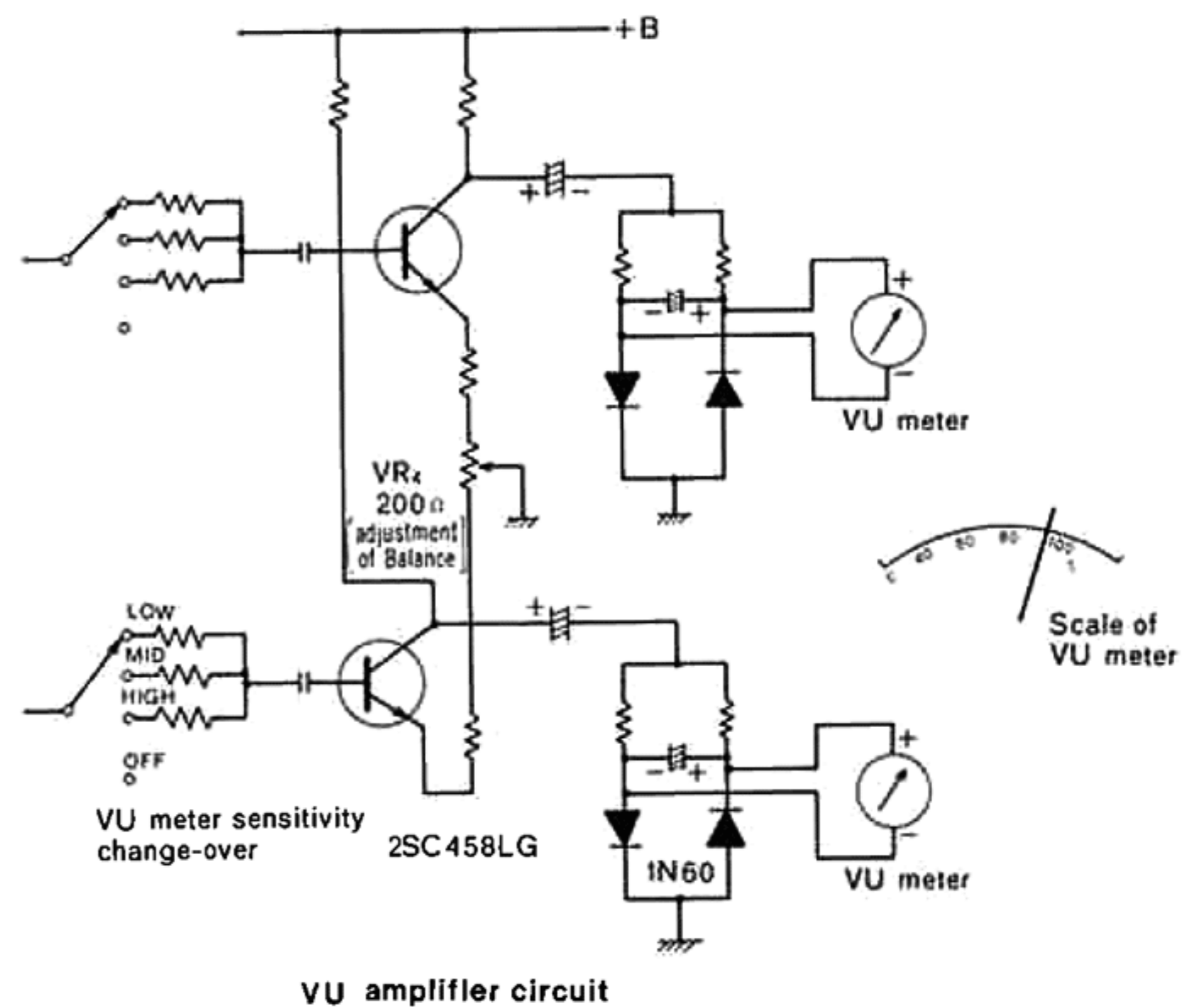
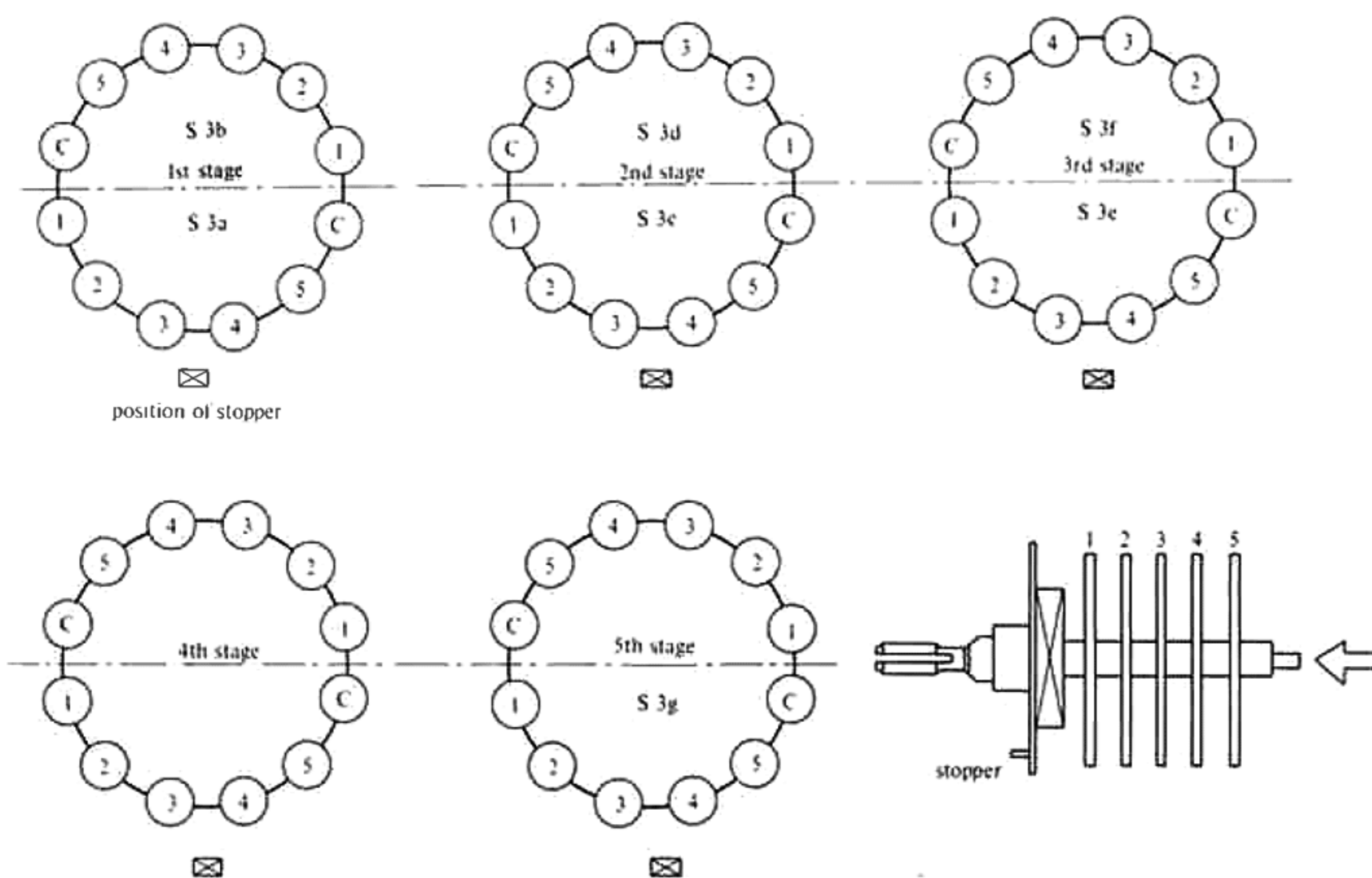



Fig. 4

4-5 Arrangement of rotary switch's terminals



This figure shows a rotary switch viewed from its rear (arrow mark). C implies COMMON, and  implies the position of a stopper.

5. CHARACTERISTICS

POWER BAND WIDTH

INPUT: TUNER

DISTORTION RATE : 0.5% constant

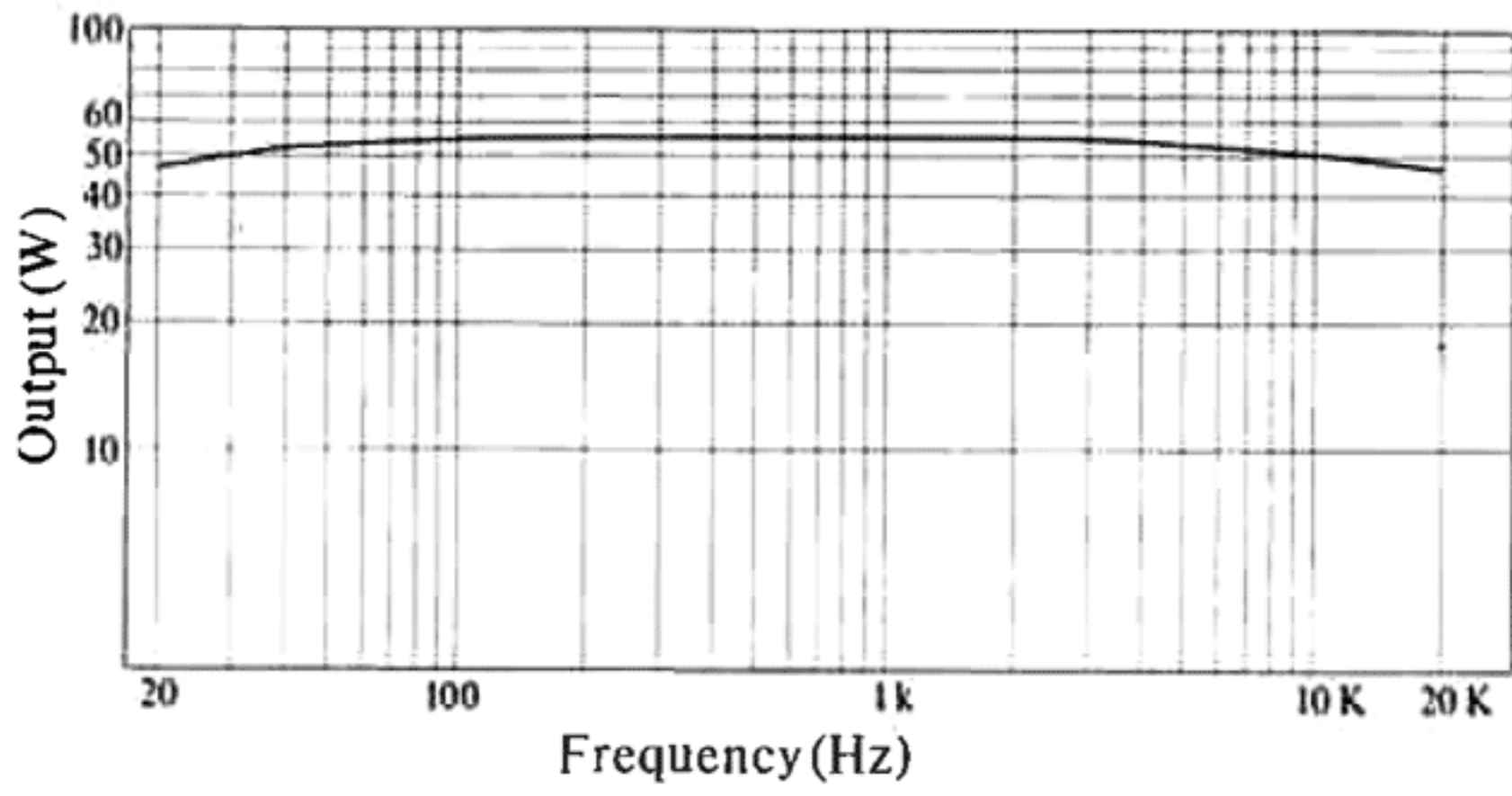

FREQUENCY CHARACTERISTIC

TONE CONTROL CHARACTERISTIC

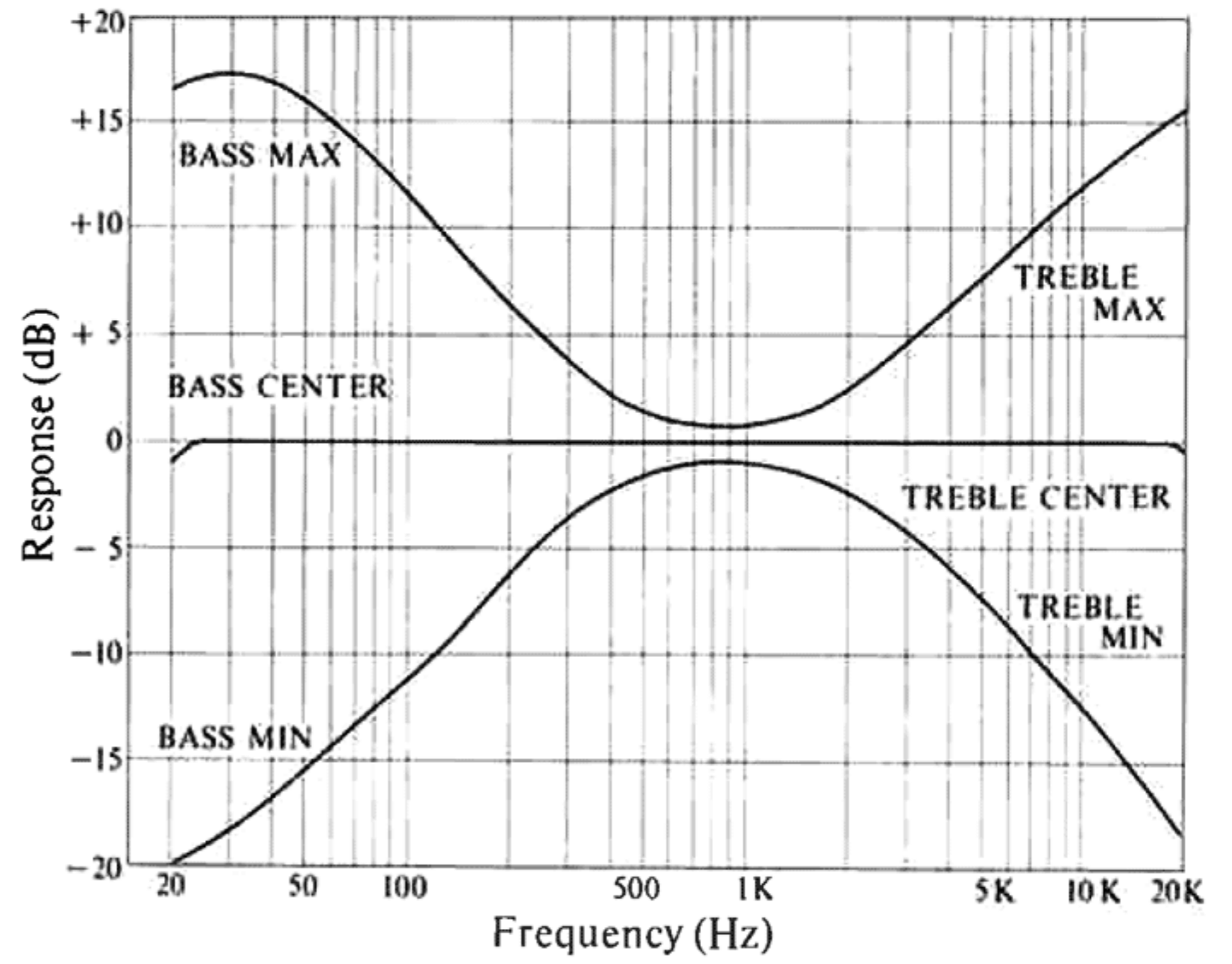

FILTER CHARACTERISTIC

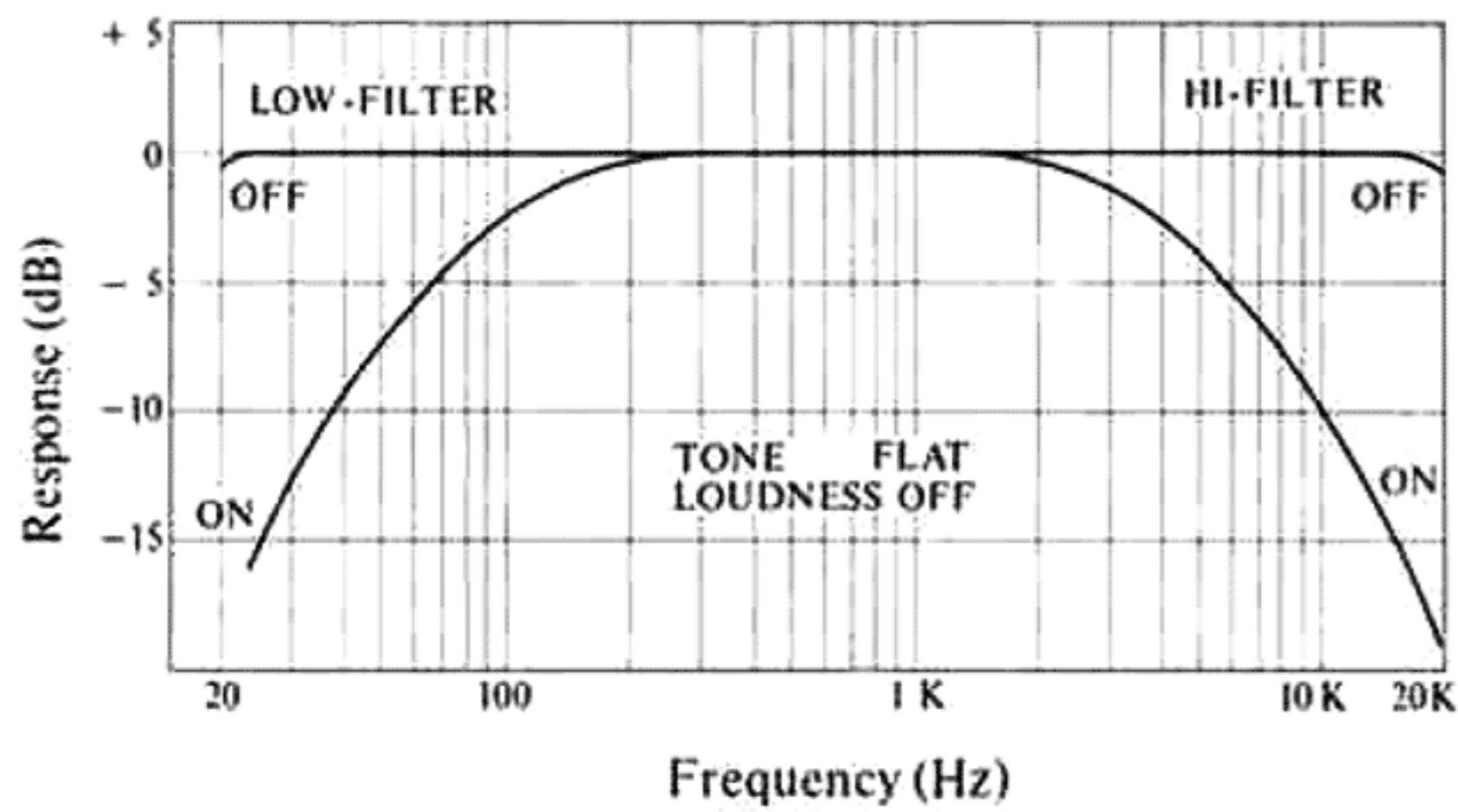

OUTPUT-AND-DISTORTION RATE

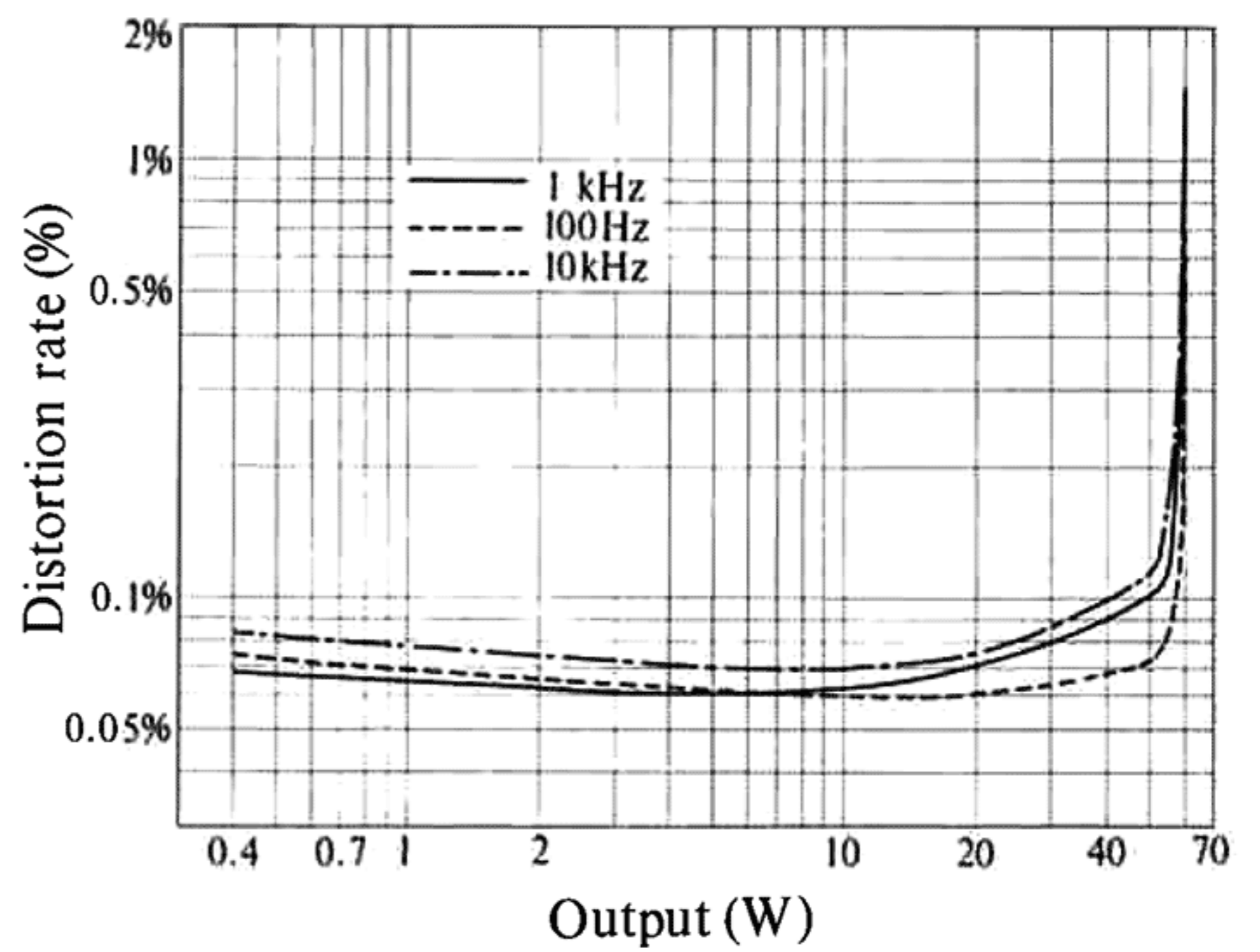

6. CHASSIS LAYOUT

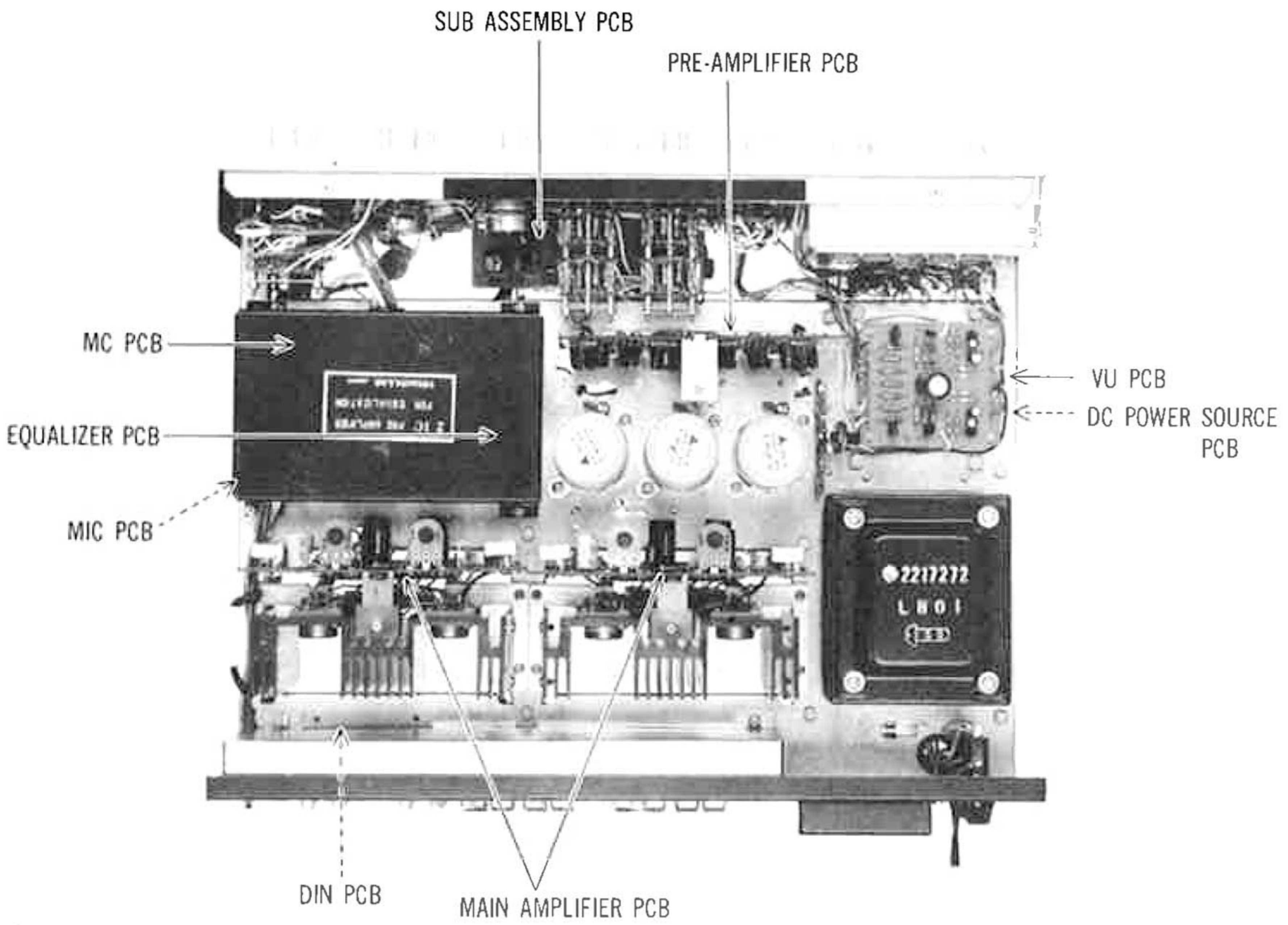

7. CIRCUIT BOARD

MC CIRCUIT BOARD

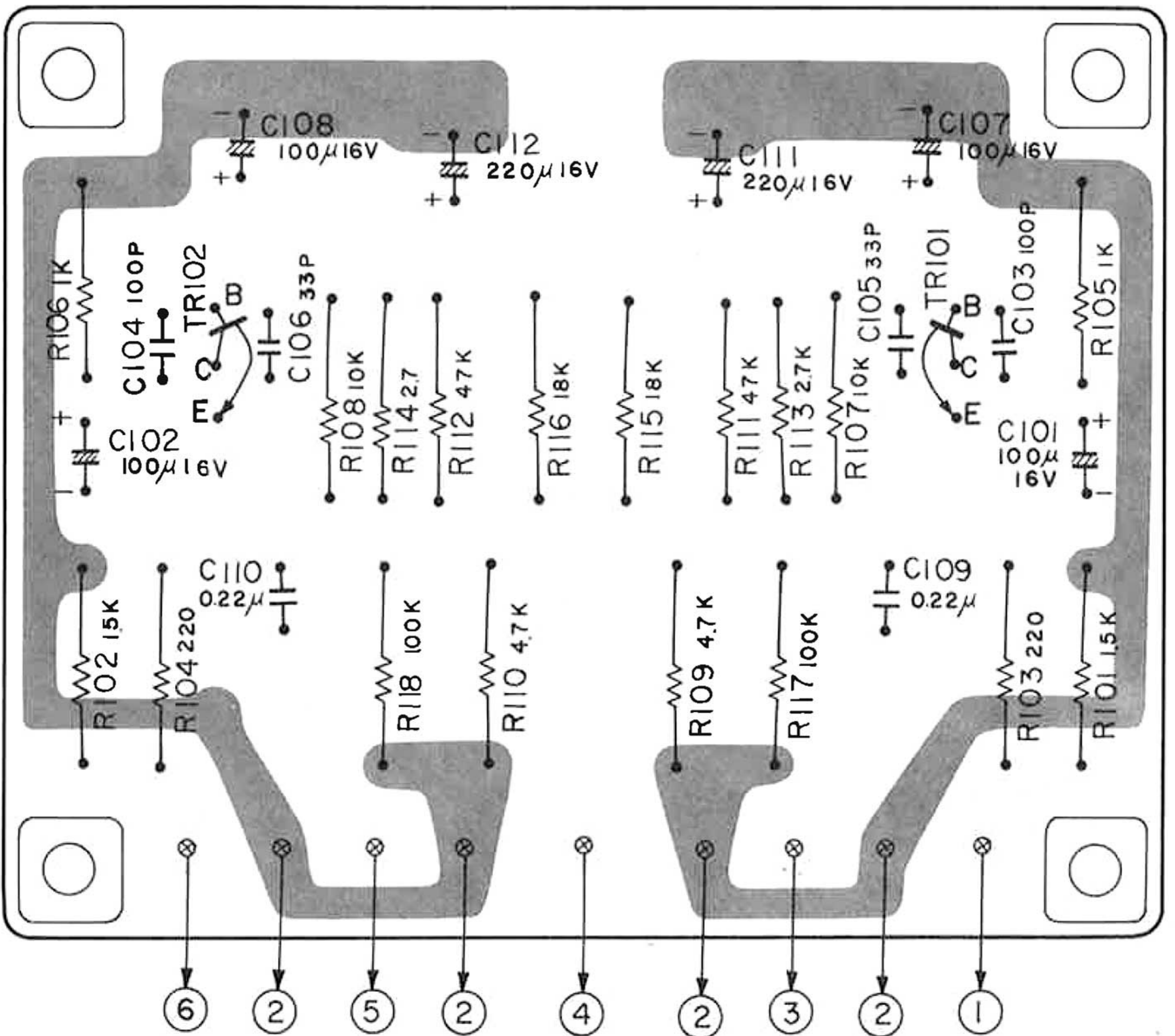

EQUALIZER CIRCUIT BOARD

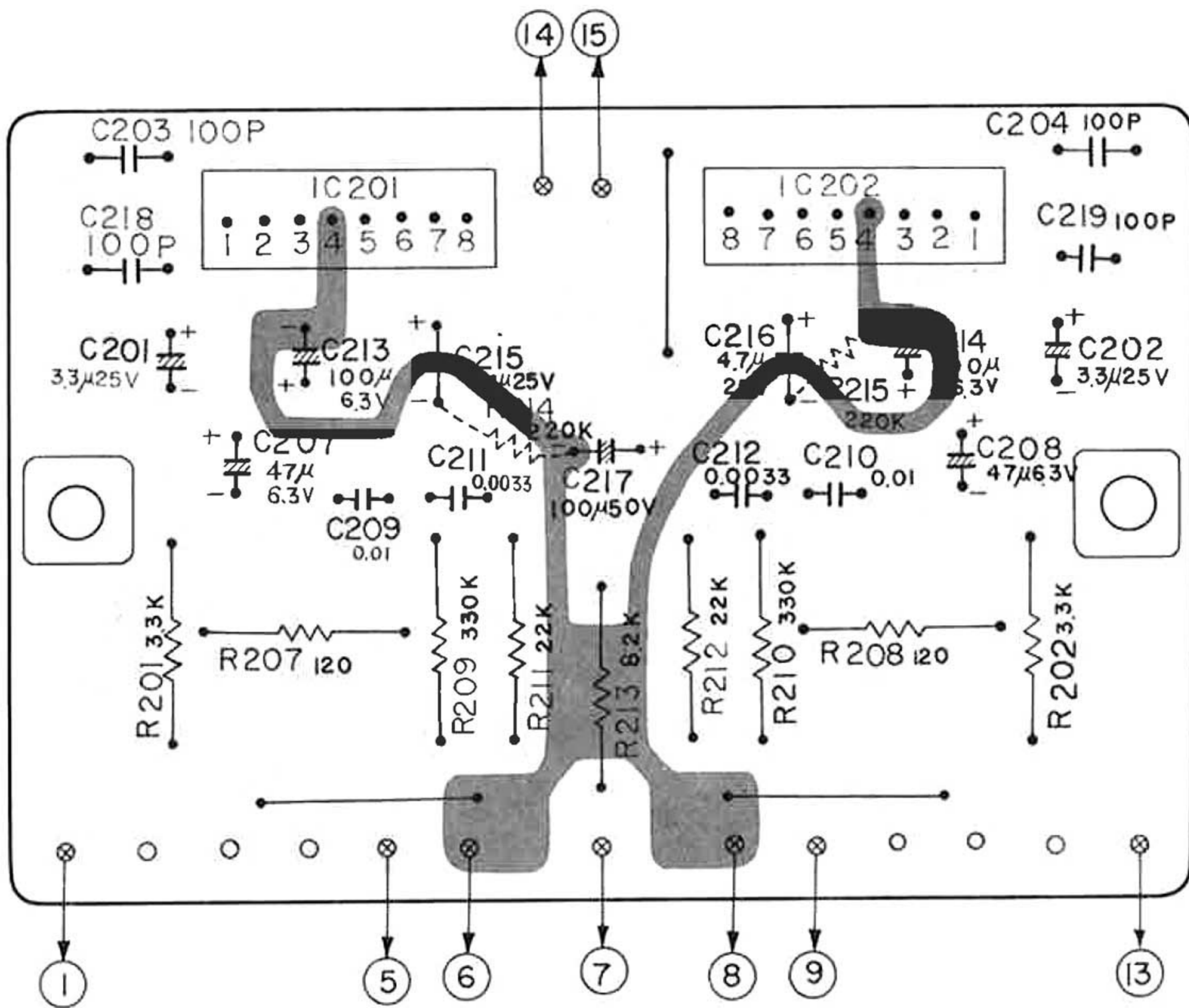

VU METER AMPLIFIER CIRCUIT BOARD

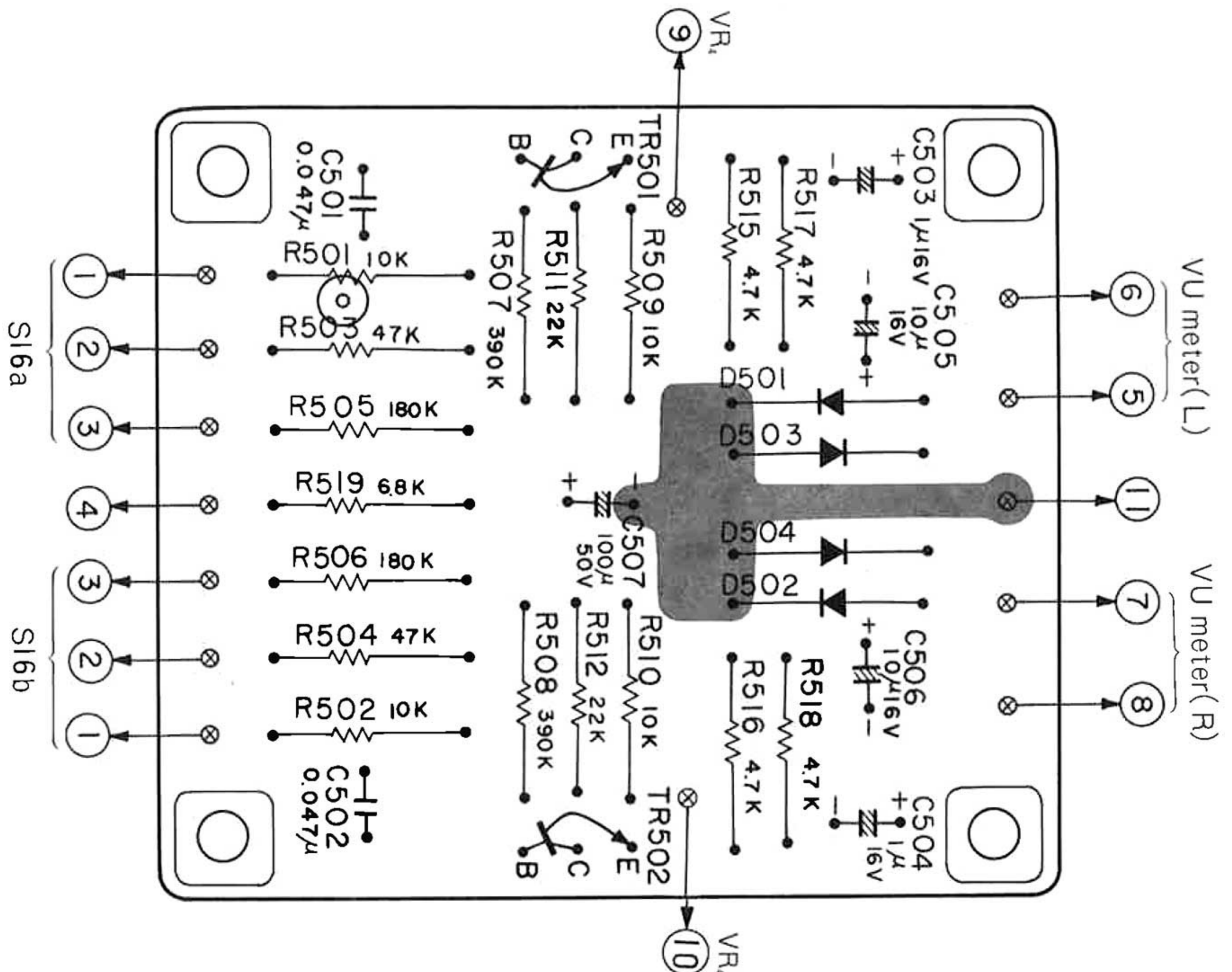

IIC AMPLIFIER CIRCUIT BOARD

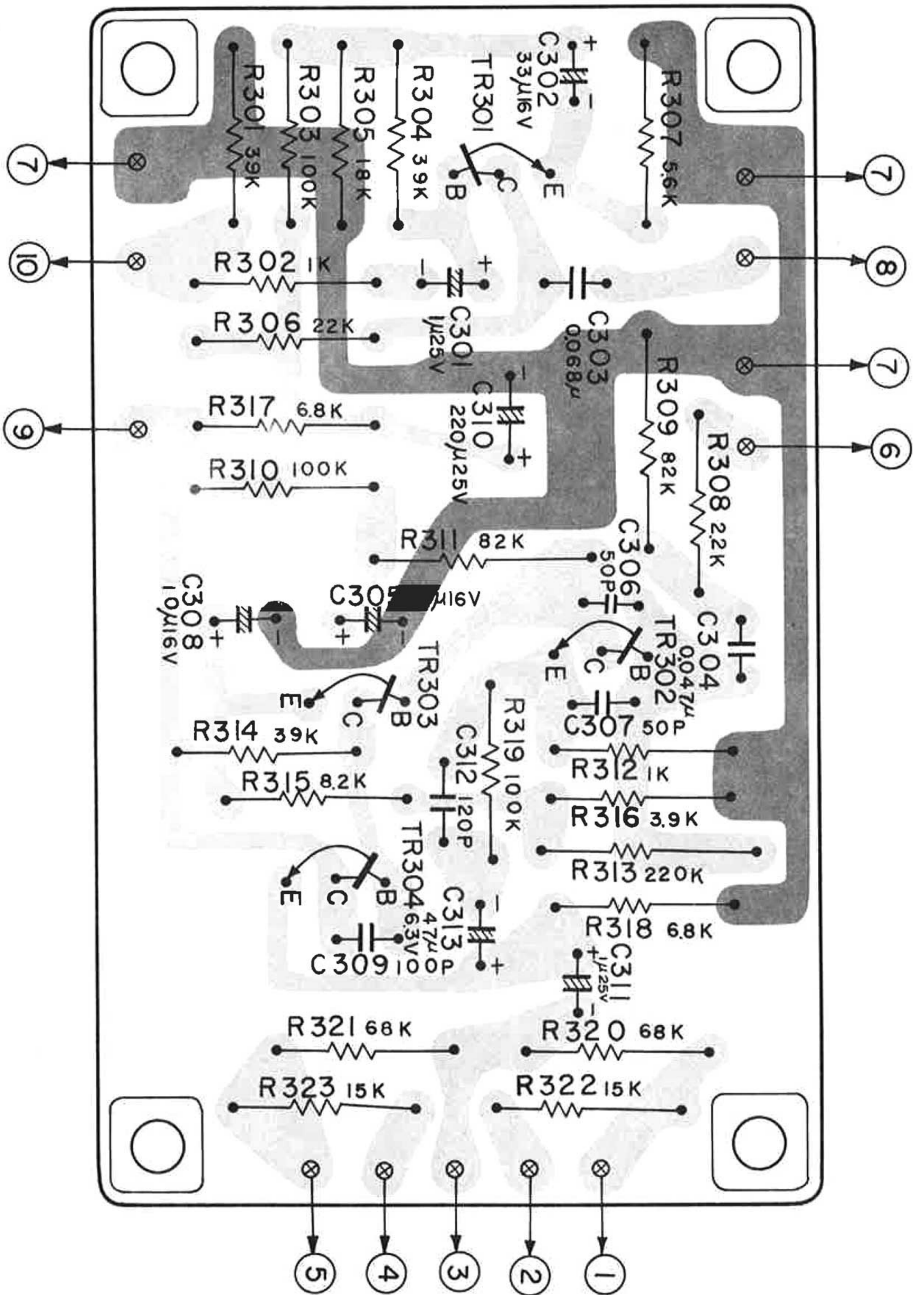

SUB ASSEMBLY CIRCUIT BOARD

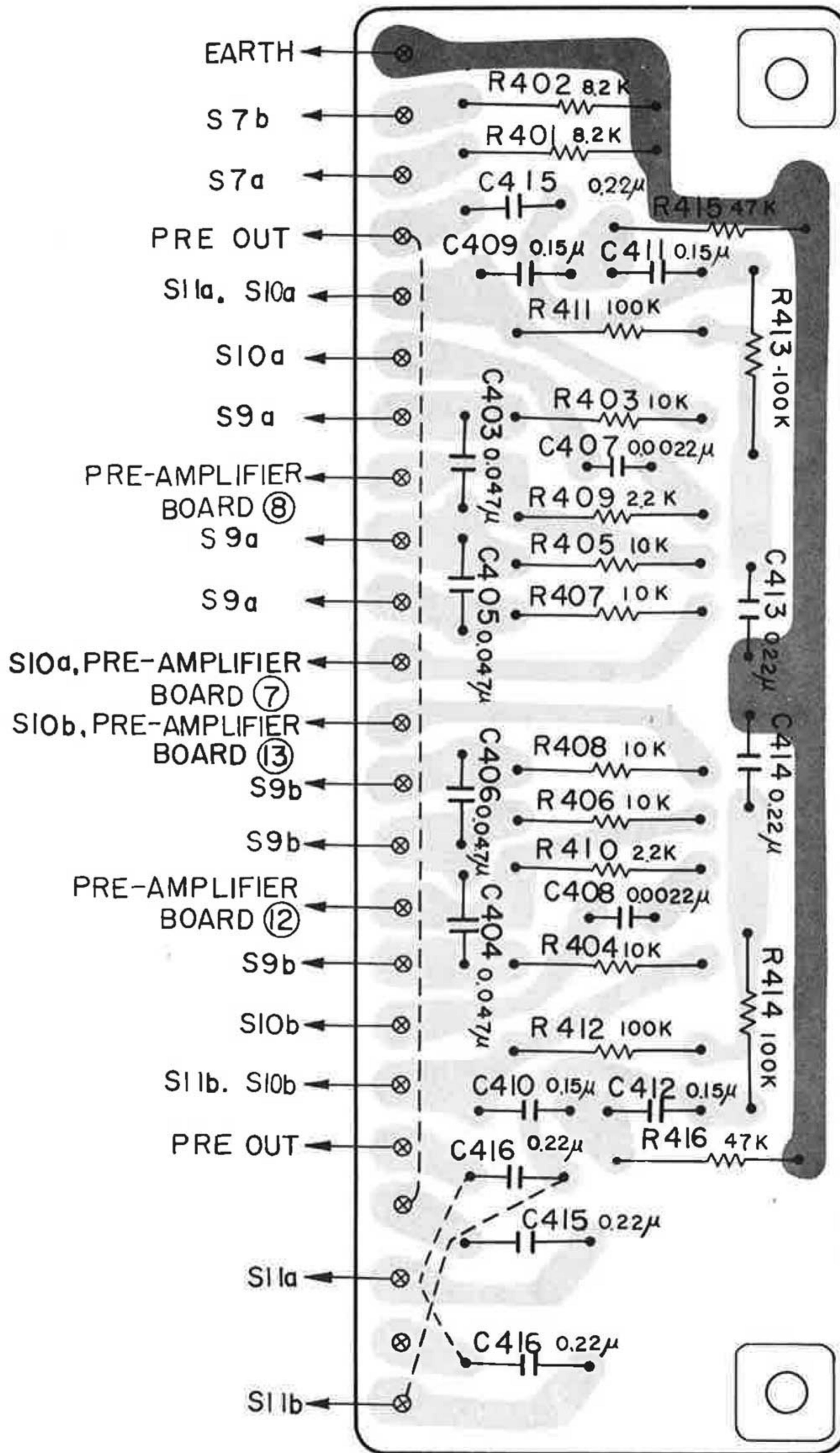

PRE-AMPLIFIER CIRCUIT BOARD

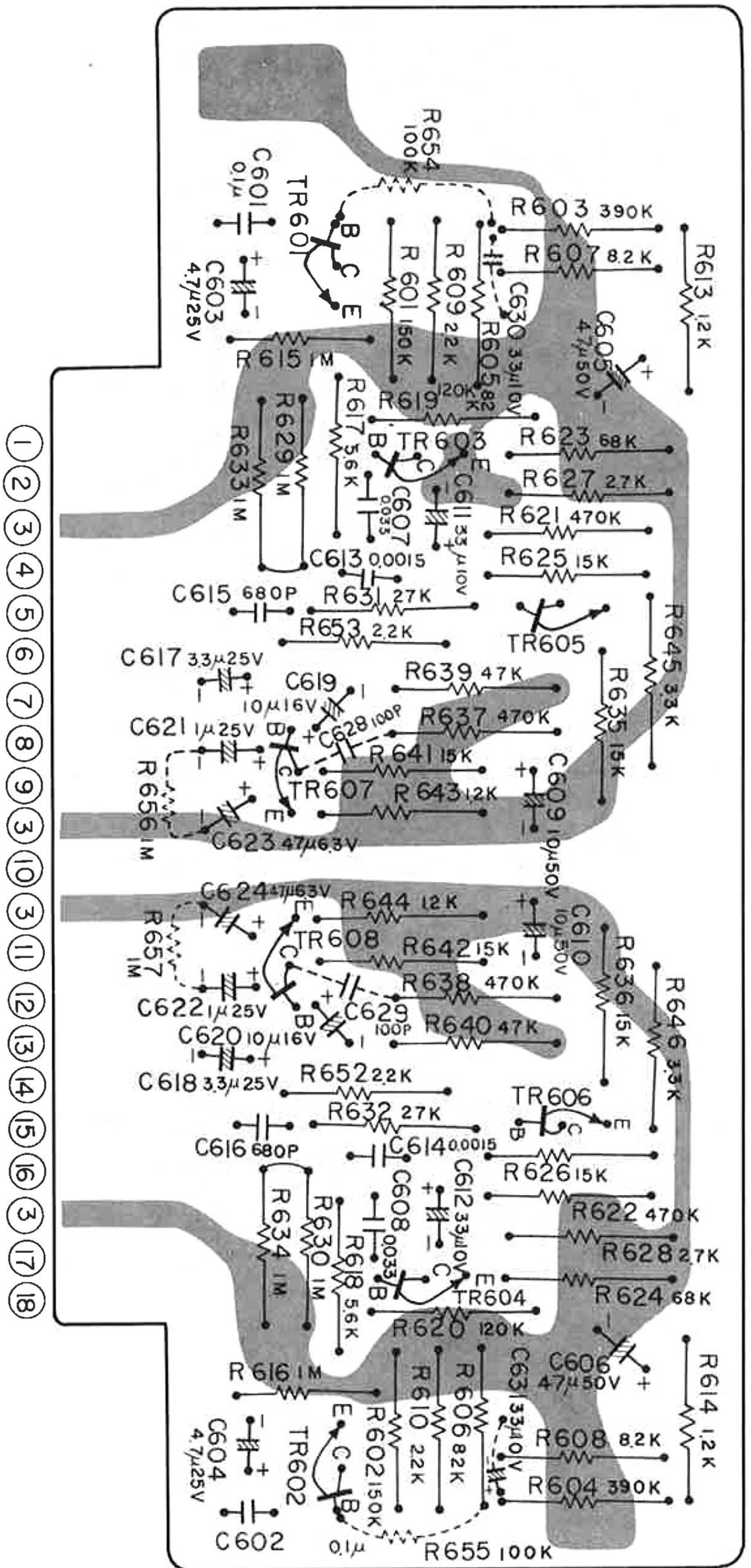

MAIN AMPLIFIER CIRCUIT BOARD

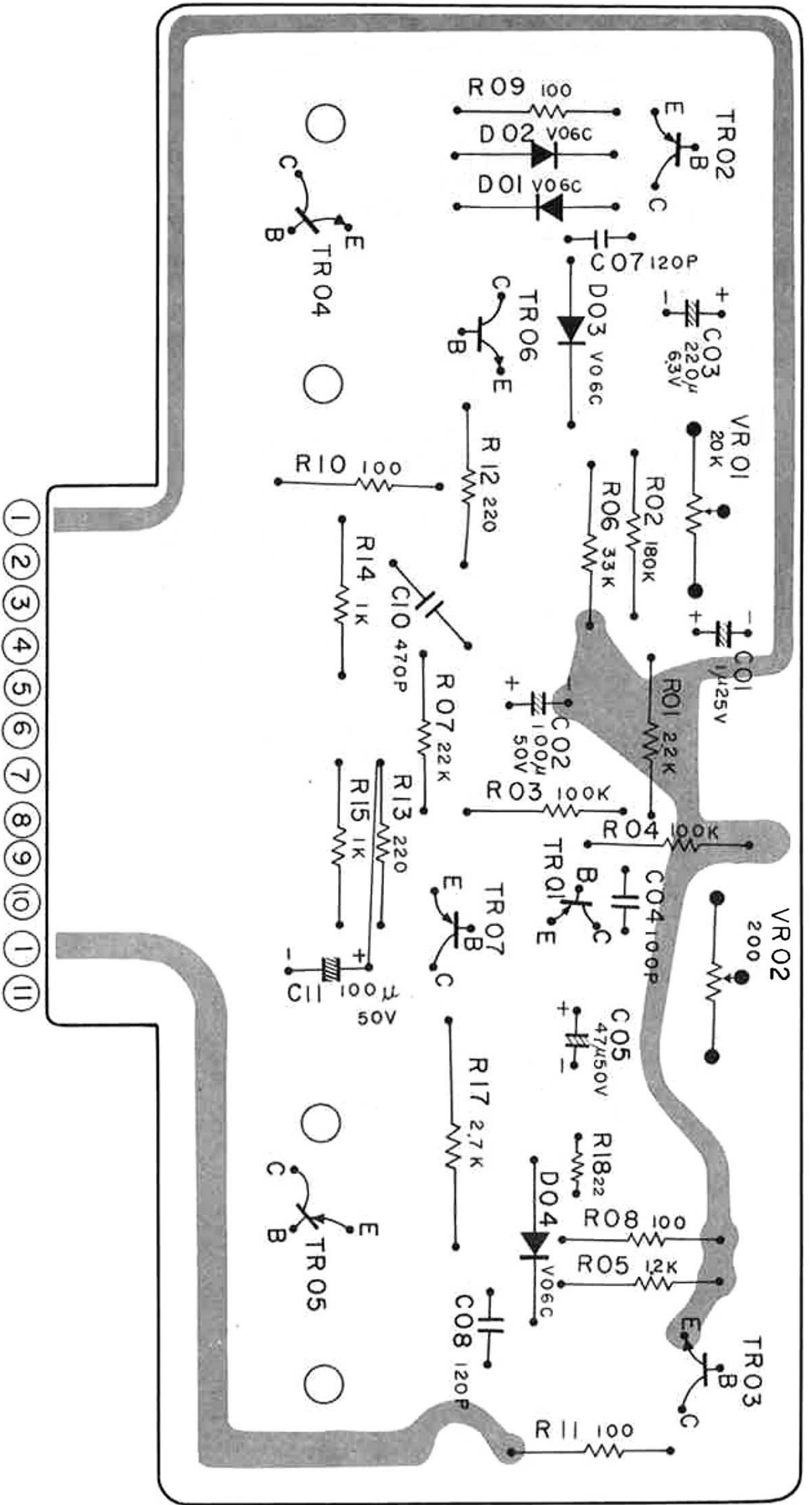

DC POWER SOURCE CIRCUIT BOARD

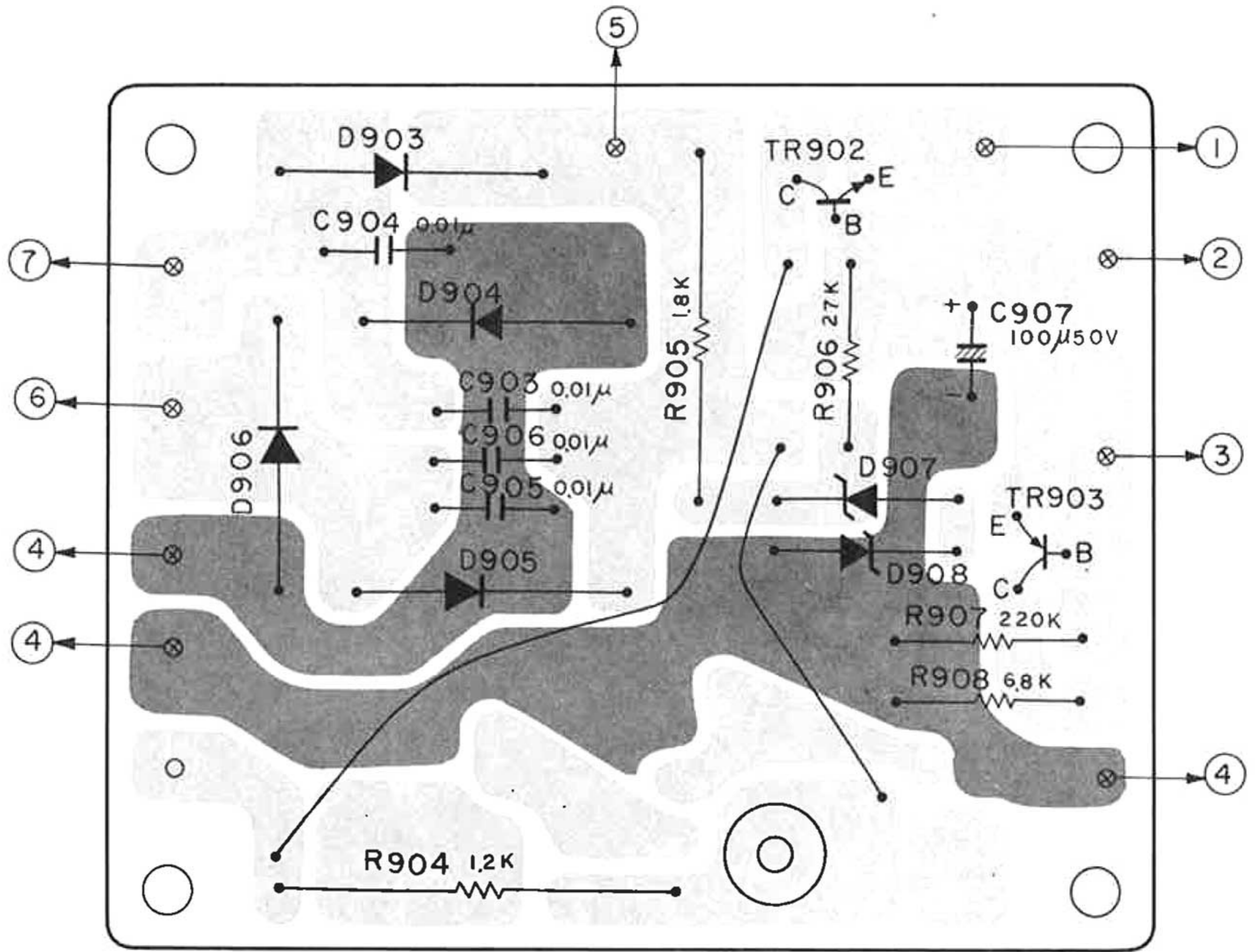

DIN CIRCUIT BOARD

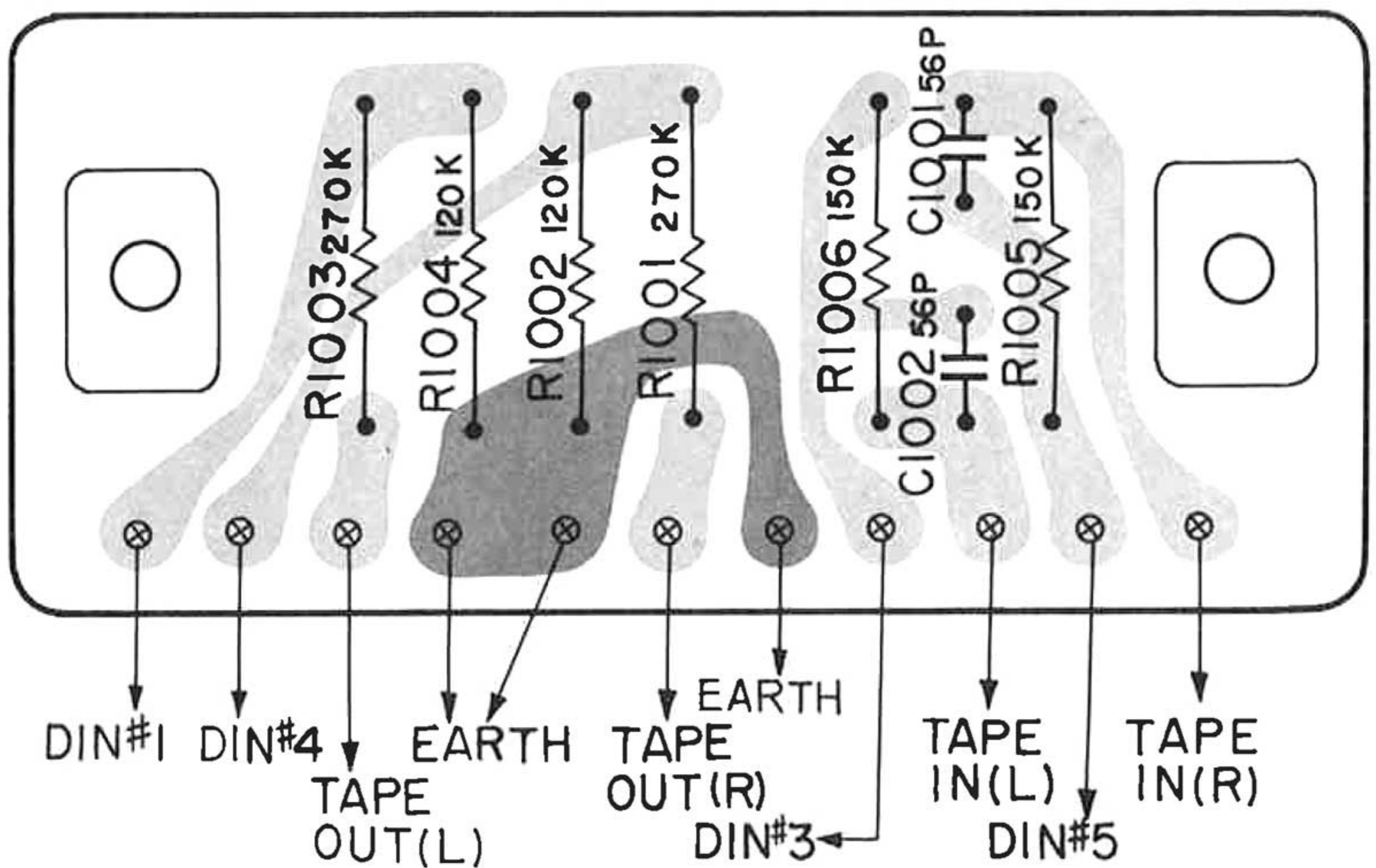

8. CIRCUIT DIAGRAM



9. REPLACEMENT PARTS LIST

SYMBOL NO.	STOCK NO.	DESCRIPTION			SYMBOL NO.	STOCK NO.	DESCRIPTION		
CAPACITORS					for VU METER AMPLIFIER CIRCUIT BOARD				
for MC CIRCUIT BOARD					C501	0275015	mylar, film	0.047 μ F	K
C101	0252531	electrolytic	100 μ F	16V	C502	0275015	mylar, film	0.047 μ F	K
C102	0252531	electrolytic	100 μ F	16V	C503	0252611	electrolytic	1 μ F	16V
C103	0248724	ceramic, discal	100pF	K	C504	0252611	electrolytic	1 μ F	16V
C104	0248724	ceramic, discal	100pF	K	C505	0252521	electrolytic	10 μ F	16V
C105	0248712	ceramic, discal	33pF	K	C506	0252521	electrolytic	10 μ F	16V
C106	0248712	ceramic, discal	33pF	K	C507	0252831	electrolytic	100 μ F	50V
C107	0252531	electrolytic	100 μ F	16V	for PRE-AMPLIFIER CIRCUIT BOARD				
C108	0252531	electrolytic	100 μ F	16V	C601	0276011	mylar, film	0.1 μ F	K
C109	0276013	mylar, film	0.22 μ F	K	C602	0276011	mylar, film	0.1 μ F	K
C110	0276013	mylar, film	0.22 μ F	K	C603	0252615	electrolytic	4.7 μ F	25V
C111	0252532	electrolytic	220 μ F	16V	C604	0252615	electrolytic	4.7 μ F	25V
C112	0252532	electrolytic	220 μ F	16V	C605	1252825	electrolytic	47 μ F	50V
for EQUALIZER CIRCUIT BOARD					C606	1252825	electrolytic	47 μ F	50V
C201	0252613	electrolytic	3.3 μ F	25V	C607	0275014	mylar, film	0.033 μ F	K
C202	0252613	electrolytic	3.3 μ F	25V	C608	0275014	mylar, film	0.033 μ F	K
C203	0248724	ceramic, discal	100pF	K	C609	0252821	electrolytic	10 μ F	50V
C204	0248724	ceramic, discal	100pF	K	C610	0252821	electrolytic	10 μ F	50V
C207	0252225	electrolytic	47 μ F	6.3V	C611	0252323	electrolytic	33 μ F	10V
C208	0252225	electrolytic	47 μ F	6.3V	C612	0252323	electrolytic	33 μ F	10V
C209	0275011	mylar, film	0.01 μ F	K	C613	0274012	mylar, film	0.0015 μ F	K
C210	0275011	mylar, film	0.01 μ F	K	C614	0274012	mylar, film	0.0015 μ F	K
C211	0274014	mylar, film	0.0033 μ F	K	C615	0221371	styrol	680pF	K
C212	0274014	mylar, film	0.0033 μ F	K	C616	0221371	styrol	680pF	K
C213	0252231	electrolytic	100 μ F	6.3V	C617	0252613	electrolytic	3.3 μ F	25V
C214	0252231	electrolytic	100 μ F	6.3V	C618	0252613	electrolytic	3.3 μ F	25V
C215	0252615	electrolytic	4.7 μ F	25V	C619	0252521	electrolytic	10 μ F	16V
C216	0252615	electrolytic	4.7 μ F	25V	C620	0252521	electrolytic	10 μ F	16V
C217	0252831	electrolytic	100 μ F	50V	C621	0252611	electrolytic	1 μ F	25V
C218	0248724	ceramic, discal	100pF	K	C622	0252611	electrolytic	1 μ F	25V
C219	0248724	ceramic, discal	100pF	K	C623	0252225	electrolytic	47 μ F	6.3V
for MIC AMPLIFIER CIRCUIT BOARD					C624	0252225	electrolytic	47 μ F	6.3V
C301	0252611	electrolytic	1 μ F	25V	C628	0248724	ceramic, discal	100pF	K
C302	0252523	electrolytic	33 μ F	16V	C629	0248724	ceramic, discal	100pF	K
C303	0275016	mylar, film	0.068 μ F	K	C630	0252323	electrolytic	33 μ F	10V
C304	0275015	mylar, film	0.047 μ F	K	C631	0252323	electrolytic	33 μ F	10V
C305	0252521	electrolytic	10 μ F	16V	for MAIN AMPLIFIER CIRCUIT BOARD				
C306	0242011	ceramic, discal	50pF	K	C701	1252611	electrolytic	1 μ F	25V
C307	0242011	ceramic, discal	50pF	K	C702	1252831	electrolytic	100 μ F	50V
C308	0252521	electrolytic	10 μ F	16V	C703	1252232	electrolytic	220 μ F	6.3V
C309	0248724	ceramic, discal	100pF	K	C704	0248724	ceramic, discal	100pF	K
C310	0252632	electrolytic	220 μ F	25V	C705	1252825	electrolytic	47 μ F	50V
C311	0252611	electrolytic	1 μ F	25V	C707	0248726	ceramic, discal	120pF	K
C312	0248726	ceramic, discal	120pF	K	C708	0248726	ceramic, discal	120pF	K
C313	0252225	electrolytic	47 μ F	6.3V	C710	0221369	styrol	470pF	K
for SUB ASSEMBLY CIRCUIT BOARD					C711	1252831	electrolytic	100 μ F	50V
C403	0275015	mylar, film	0.047 μ F		C801	1252611	electrolytic	1 μ F	25V
C404	0275015	mylar, film	0.047 μ F		C802	1252831	electrolytic	100 μ F	50V
C405	0275015	mylar, film	0.047 μ F		C803	1252232	electrolytic	220 μ F	6.3V
C406	0275015	mylar, film	0.047 μ F		C804	0248724	ceramic, discal	100pF	K
C407	0274013	mylar, film	0.0022 μ F		C805	1252825	electrolytic	47 μ F	50V
C408	0274013	mylar, film	0.0022 μ F		C807	0248726	ceramic, discal	120pF	K
C409	0276012	mylar, film	0.15 μ F		C808	0248726	ceramic, discal	120pF	K
C410	0276012	mylar, film	0.15 μ F		C810	0221369	styrol	470pF	K
C411	0276012	mylar, film	0.15 μ F		C811	1252831	electrolytic	100 μ F	50V
C412	0276012	mylar, film	0.15 μ F		for DC POWER SOURCE CIRCUIT BOARD				
C413	0276013	mylar, film	0.22 μ F		C903	0245408	ceramic, discal	0.01 μ F	500V
C414	0276013	mylar, film	0.22 μ F		C904	0245408	ceramic, discal	0.01 μ F	500V
C415	0276013	mylar, film	0.22 μ F						
C415	0276013	mylar, film	0.22 μ F						
C416	0276013	mylar, film	0.22 μ F						
C416	0276013	mylar, film	0.22 μ F						

SYMBOL NO.	STOCK NO.	DESCRIPTION			SYMBOL NO.	STOCK NO.	DESCRIPTION		
C905	0245408	ceramic, discal	0.01 μ F	500V	R304	1114528	carbon, film	39k Ω	K SRD $\frac{1}{4}$ P
C906	0245408	ceramic, discal	0.01 μ F	500V	R305	1114524	carbon, film	18k Ω	K SRD $\frac{1}{4}$ P
C907	1252831	electrolytic	100 μ F	50V	R306	1114525	carbon, film	22k Ω	K SRD $\frac{1}{4}$ P
for DIN CIRCUIT BOARD					R307	1114470	carbon, film	5.6k Ω	K SRD $\frac{1}{4}$ P
C1001	0248718	ceramic, discal	56pF	K	R308	1114465	carbon, film	2.2k Ω	K SRD $\frac{1}{4}$ P
C1002	0248718	ceramic, discal	56pF	K	R309	0112474	carbon, film	82k Ω	K NLRD $\frac{1}{4}$ P
for CHASSIS ASSEMBLY					R310	1114541	carbon, film	100k Ω	K SRD $\frac{1}{4}$ P
C 1	0252525	electrolytic	47 μ F		R311	0112474	carbon, film	82k Ω	K NLRD $\frac{1}{4}$ P
C 2	0252525	electrolytic	47 μ F		R312	1114461	carbon, film	1k Ω	K SRD $\frac{1}{4}$ P
C 3	0275016	mylar, film	0.068 μ F	K	R313	0112537	carbon, film	220k Ω	K NLRD $\frac{1}{4}$ P
C 4	0275016	mylar, film	0.068 μ F	K	R314	1114528	carbon, film	39k Ω	K SRD $\frac{1}{4}$ P
C 7	0259797	mylar, film	2200 μ F	90V	R315	1114472	carbon, film	8.2k Ω	K SRD $\frac{1}{4}$ P
C 8	0259797	mylar, film	2200 μ F	90V	R316	1114468	carbon, film	3.9k Ω	K SRD $\frac{1}{4}$ P
C 9	0276011	mylar, film	0.1 μ	K	R317	1114471	carbon, film	6.8k Ω	K SRD $\frac{1}{4}$ P
C 10	0276011	mylar, film	0.1 μ	K	R318	1114471	carbon, film	6.8k Ω	K SRD $\frac{1}{4}$ P
C 11	0259797	electrolytic	2200 μ F	90V	R319	1114531	carbon, film	100k Ω	K SRD $\frac{1}{4}$ P
C 12	0214469	ceramic, discal	0.01 μ F		R320	1114541	carbon, film	68k Ω	K SRD $\frac{1}{4}$ P
C 13	0275011	mylar, film	0.01 μ F	K	R321	1114541	carbon, film	68k Ω	K SRD $\frac{1}{4}$ P
C 14	0275011	mylar, film	0.01 μ F	K	R322	1114531	carbon, film	15k Ω	K SRD $\frac{1}{4}$ P
C 17	0243415	ceramic, discal	470pF	J	R323	1114531	carbon, film	15k Ω	K SRD $\frac{1}{4}$ P
	0248728	ceramic, discal	150pF	K 50V	for SUB ASSEMBLY CIRCUIT BOARD				
C 18	0243415	ceramic, discal	470pF	J	R401	1114472	carbon, film	8.2k Ω	K SRD $\frac{1}{4}$ P
	0248728	ceramic, discal	150pF	K 50V	R402	1114472	carbon, film	8.2k Ω	K SRD $\frac{1}{4}$ P
C 19	0276013	mylar, film	0.22 μ F	K 50V	R403	1114521	carbon, film	10k Ω	K SRD $\frac{1}{4}$ P
C 20	0276013	mylar, film	0.22 μ F	K 50V	R404	1114521	carbon, film	10k Ω	K SRD $\frac{1}{4}$ P
RESISTORS					R405	1114521	carbon, film	10k Ω	K SRD $\frac{1}{4}$ P
for MC CIRCUIT BOARD					R406	1114521	carbon, film	10k Ω	K SRD $\frac{1}{4}$ P
R101	1114463	carbon, film	1.5k Ω	K SRD $\frac{1}{4}$ P	R407	1114521	carbon, film	10k Ω	K SRD $\frac{1}{4}$ P
R102	1114463	carbon, film	1.5k Ω	K SRD $\frac{1}{4}$ P	R408	1114521	carbon, film	10k Ω	K SRD $\frac{1}{4}$ P
R103	1114445	carbon, film	220 Ω	K SRD $\frac{1}{4}$ P	R409	1114465	carbon, film	2.2k Ω	K SRD $\frac{1}{4}$ P
R104	1114445	carbon, film	220 Ω	K SRD $\frac{1}{4}$ P	R410	1114465	carbon, film	2.2k Ω	K SRD $\frac{1}{4}$ P
R105	1114461	carbon, film	1k Ω	K SRD $\frac{1}{4}$ P	R411	1114541	carbon, film	100k Ω	K SRD $\frac{1}{4}$ P
R106	1114461	carbon, film	1k Ω	K SRD $\frac{1}{4}$ P	R412	1114541	carbon, film	100k Ω	K SRD $\frac{1}{4}$ P
R107	1114521	carbon, film	10k Ω	K SRD $\frac{1}{4}$ P	R413	1114541	carbon, film	100k Ω	K SRD $\frac{1}{4}$ P
R108	1114521	carbon, film	10k Ω	K SRD $\frac{1}{4}$ P	R414	1114541	carbon, film	100k Ω	K SRD $\frac{1}{4}$ P
R109	1114469	carbon, film	4.7k Ω	K SRD $\frac{1}{4}$ P	R415	1114529	carbon, film	47k Ω	K SRD $\frac{1}{4}$ P
R110	1114469	carbon, film	4.7k Ω	K SRD $\frac{1}{4}$ P	R416	1114529	carbon, film	47k Ω	K SRD $\frac{1}{4}$ P
R111	1114529	carbon, film	47k Ω	K SRD $\frac{1}{4}$ P	for VU METER AMPLIFIER CIRCUIT BOARD				
R112	1114529	carbon, film	47k Ω	K SRD $\frac{1}{4}$ P	R501	1114521	carbon, film	10k Ω	K SRD $\frac{1}{4}$ P
R113	1114461	carbon, film	2.7k Ω	K SRD $\frac{1}{4}$ P	R502	1114521	carbon, film	10k Ω	K SRD $\frac{1}{4}$ P
R114	1114461	carbon, film	2.7k Ω	K SRD $\frac{1}{4}$ P	R503	1114529	carbon, film	47k Ω	K SRD $\frac{1}{4}$ P
R115	1114524	carbon, film	18k Ω	K SRD $\frac{1}{4}$ P	R504	1114529	carbon, film	47k Ω	K SRD $\frac{1}{4}$ P
R116	1114524	carbon, film	18k Ω	K SRD $\frac{1}{4}$ P	R505	1114544	carbon, film	180k Ω	K SRD $\frac{1}{4}$ P
R117	1114541	carbon, film	100k Ω	K SRD $\frac{1}{4}$ P	R506	1114544	carbon, film	180k Ω	K SRD $\frac{1}{4}$ P
R118	1114541	carbon, film	100k Ω	K SRD $\frac{1}{4}$ P	R507	1114548	carbon, film	390k Ω	K SRD $\frac{1}{4}$ P
for EQUALIZER CIRCUIT BOARD					R508	1114548	carbon, film	390k Ω	K SRD $\frac{1}{4}$ P
R201	1114467	carbon, film	3.3k Ω	K SRD $\frac{1}{4}$ P	R509	1114521	carbon, film	10k Ω	K SRD $\frac{1}{4}$ P
R202	1114467	carbon, film	3.3k Ω	K SRD $\frac{1}{4}$ P	R510	1114521	carbon, film	10k Ω	K SRD $\frac{1}{4}$ P
R207	1114442	carbon, film	120 Ω	K SRD $\frac{1}{4}$ P	R511	1114525	carbon, film	22k Ω	K SRD $\frac{1}{4}$ P
R208	1114442	carbon, film	120 Ω	K SRD $\frac{1}{4}$ P	R512	1114525	carbon, film	22k Ω	K SRD $\frac{1}{4}$ P
R209	1114547	carbon, film	330k Ω	K SRD $\frac{1}{4}$ P	R515	1114469	carbon, film	4.7k Ω	K SRD $\frac{1}{4}$ P
R210	1114547	carbon, film	330k Ω	K SRD $\frac{1}{4}$ P	R516	1114469	carbon, film	4.7k Ω	K SRD $\frac{1}{4}$ P
R211	1114525	carbon, film	22k Ω	K SRD $\frac{1}{4}$ P	R517	1114469	carbon, film	4.7k Ω	K SRD $\frac{1}{4}$ P
R212	1114525	carbon, film	22k Ω	K SRD $\frac{1}{4}$ P	R518	1114469	carbon, film	4.7k Ω	K SRD $\frac{1}{4}$ P
R213	1114472	carbon, film	8.2k Ω	K SRD $\frac{1}{4}$ P	R519	1114471	carbon, film	6.8k Ω	K SRD $\frac{1}{4}$ P
R214	1114545	carbon, film	220k Ω	K SRD $\frac{1}{4}$ P	for PRE-AMPLIFIER CIRCUIT BOARD				
R215	1114545	carbon, film	220k Ω	K SRD $\frac{1}{4}$ P	R601	1114543	carbon, film	150k Ω	K SRD $\frac{1}{4}$ P
for MIC AMPLIFIER CIRCUIT BOARD					R602	1114543	carbon, film	150k Ω	K SRD $\frac{1}{4}$ P
R301	1114528	carbon, film	39k Ω	K SRD $\frac{1}{4}$ P	R603	1114548	carbon, film	390k Ω	K SRD $\frac{1}{4}$ P
R302	1114461	carbon, film	1k Ω	K SRD $\frac{1}{4}$ P	R604	1114548	carbon, film	390k Ω	K SRD $\frac{1}{4}$ P
R303	1114541	carbon, film	100k Ω	K SRD $\frac{1}{4}$ P	R605	1114532	carbon, film	82k Ω	K SRD $\frac{1}{4}$ P
					R606	1114532	carbon, film	82k Ω	K SRD $\frac{1}{4}$ P
					R607	1114472	carbon, film	8.2k Ω	K SRD $\frac{1}{4}$ P
					R608	1114472	carbon, film	8.2k Ω	K SRD $\frac{1}{4}$ P
					R609	1114465	carbon, film	2.2k Ω	K SRD $\frac{1}{4}$ P

SYMBOL NO.	STOCK NO.	DESCRIPTION				SYMBOL NO.	STOCK NO.	DESCRIPTION			
R610	1114465	carbon, film	2.2kΩ	K	SRD¼P	R804	1114541	carbon, film	100kΩ	K	SRD¼P
R613	1114462	carbon, film	1.2kΩ	K	SRD¼P	R805	1114462	carbon, film	1.2kΩ	K	SRD¼P
R614	1114462	carbon, film	1.2kΩ	K	SRD¼P	R806	0134391	composition	33kΩ	K	RC½GF
R615	0131844	composition	1MΩ	K	RC½GF	R807	0114525	carbon, film	22kΩ	K	SRD¼P
R616	0131844	composition	1MΩ	K	RC½GF	R808	1114441	carbon, film	100Ω	K	SRD¼P
R617	1114470	carbon, film	5.6kΩ	K	SRD¼P	R809	1114441	carbon, film	100Ω	K	SRD¼P
R618	1114470	carbon, film	5.6kΩ	K	SRD¼P	R810	1114441	carbon, film	100Ω	K	SRD¼P
R619	1114542	carbon, film	120kΩ	K	SRD¼P	R811	1114441	carbon, film	100Ω	K	SRD¼P
R620	1114542	carbon, film	120kΩ	K	SRD¼P	R812	1114139	carbon, film	220Ω	J	SRD¼P
R621	1114549	carbon, film	470kΩ	K	SRD¼P	R813	1114139	carbon, film	220Ω	J	SRD¼P
R622	1114549	carbon, film	470kΩ	K	SRD¼P	R814	1114161	carbon, film	1kΩ	J	SRD¼P
R623	1114531	carbon, film	68kΩ	K	SRD¼P	R815	1114161	carbon, film	1kΩ	J	SRD¼P
R624	1114531	carbon, film	68kΩ	K	SRD¼P	R817	1114464	carbon; film	2.7kΩ	J	SRD¼P
R625	1114523	carbon, film	15kΩ	K	SRD¼P	R818	0138293	carbon, film	22Ω	J	SRD¼SD
R626	1114523	carbon, film	15kΩ	K	SRD¼P	for DC POWER SOURCE CIRCUIT BOARD					
R627	1114466	carbon, film	2.7kΩ	K	SRD¼P	R904	0111419	carbon, film	1.2kΩ	K	RD2PA
R628	1114466	carbon, film	2.7kΩ	K	SRD¼P	R905	0111246	carbon, film	1.8kΩ	K	RD1PA
R629	0131844	composition	1MΩ	K	RC½GF	R906	0134390	composition	27kΩ	K	RC½GF
R630	0131844	composition	1MΩ	K	RC½GF	R907	0134401	composition	220kΩ	K	RC½GF
R631	1114526	carbon, film	27kΩ	K	SRD¼P	R908	0134383	composition	6.8kΩ	K	RC½GF
R632	1114526	carbon, film	27kΩ	K	SRD¼P	for DIN CIRCUIT BOARD					
R633	0131844	composition	1MΩ	K	RC½GF	R1001	1114546	carbon, film	270kΩ	K	SRD¼P
R634	0131844	composition	1MΩ	K	RC½GF	R1002	1114542	carbon, film	120kΩ	K	SRD¼P
R635	1114523	carbon, film	15kΩ	K	SRD¼P	R1003	1114546	carbon, film	270kΩ	K	SRD¼P
R636	1114523	carbon, film	15kΩ	K	SRD¼P	R1004	1114542	carbon, film	120kΩ	K	SRD¼P
R637	1114549	carbon, film	470kΩ	K	SRD¼P	R1005	1114543	carbon, film	150kΩ	K	SRD¼P
R638	1114549	carbon, film	470kΩ	K	SRD¼P	R1006	1114543	carbon, film	150kΩ	K	SRD¼P
R639	1114529	carbon, film	47kΩ	K	SRD¼P	for CHASSIS ASSEMBLY					
R640	1114529	carbon, film	47kΩ	K	SRD¼P	R 15	0114451	carbon, film	680Ω	K	SRD¼P
R641	1114523	carbon, film	15kΩ	K	SRD¼P	R 16	0114451	carbon, film	680Ω	K	SRD¼P
R642	1114523	carbon, film	15kΩ	K	SRD¼P	R 17	0114528	carbon, film	39kΩ	K	SRD¼P
R643	1114462	carbon, film	1.2kΩ	K	SRD¼P	R 18	0114528	carbon, film	39kΩ	K	SRD¼P
R644	1114462	carbon, film	1.2kΩ	K	SRD¼P	R 19	0131810	composition	560kΩ	K	RC½GF
R645	1114467	carbon, film	3.3kΩ	K	SRD¼P	R 20	0131810	composition	560kΩ	K	RC½GF
R646	1114467	carbon, film	3.3kΩ	K	SRD¼P	R 21	0142228	wire-wound	0.5Ω	K	RWC5PS
R652	1114465	carbon, film	2.2kΩ	K	SRD¼P	R 22	0142228	wire-wound	0.5Ω	K	RWC5PS
R653	1114465	carbon, film	2.2kΩ	K	SRD¼P	R 23	0142228	wire-wound	0.5Ω	K	RWC5PS
R654	0114541	carbon, film	100kΩ	K	SRD¼P	R 24	0142228	wire-wound	0.5Ω	K	RWC5PS
R655	0114541	carbon, film	100kΩ	K	SRD¼P	R 25	0142229	wire-wound	10Ω	K	RWC2PS
R656	0131844	composition	1MΩ	K	RC½GF	R 26	0142229	wire-wound	10Ω	K	RWC2PS
R657	0131844	composition	1MΩ	K	RC½GF	R 27	0111416	metal oxide	680Ω	K	RDZPA
for MAIN AMPLIFIER CIRCUIT BOARD						R 28	0111416	metal oxide	680Ω	K	RDZPA
R701	1114465	carbon, film	2.2kΩ	K	SRD¼P	R 29	0111410	metal oxide	220Ω	K	RDZPA
R702	1114544	carbon, film	180kΩ	K	SRD¼P	R 30	0111410	metal oxide	220Ω	K	RDZPA
R703	1114541	carbon, film	100kΩ	K	SRD¼P	R 31	0114468	carbon, film	3.9kΩ	K	SRD¼P
R704	1114541	carbon, film	100kΩ	K	SRD¼P	R 32	0114468	carbon, film	3.9kΩ	K	SRD¼P
R705	1114462	carbon, film	1.2kΩ	K	SRD¼P	R 33	0114470	carbon, film	5.6kΩ	K	SRD¼P
R706	0134371	composition	33kΩ	K	RC½GF	R 34	0114470	carbon, film	5.6kΩ	K	SRD¼P
R707	0114525	carbon, film	22kΩ	K	SRD¼P	R 35	0114521	carbon, film	10kΩ	K	SRD¼P
R708	1114441	carbon, film	100Ω	K	SRD¼P	R 36	0114521	carbon, film	10kΩ	K	SRD¼P
R709	1114441	carbon, film	100Ω	K	SRD¼P	R 37	0114527	carbon, film	33kΩ	K	SRD¼P
R710	1114441	carbon, film	100Ω	K	SRD¼P	R 38	0114527	carbon, film	33kΩ	K	SRD¼P
R711	1114441	carbon, film	100Ω	K	SRD¼P	R 39	0114527	carbon, film	33kΩ	K	SRD¼P
R712	1114139	carbon, film	220Ω	J	SRD¼P	R 40	0114527	carbon, film	33kΩ	K	SRD¼P
R713	1114139	carbon, film	220Ω	J	SRD¼P	R 41	0114521	carbon, film	10kΩ	K	SRD¼P
R714	1114161	carbon, film	1kΩ	J	SRD¼P	R 42	0114521	carbon, film	10kΩ	K	SRD¼P
R715	1114161	carbon, film	1kΩ	J	SRD¼P	R 43	0114470	carbon, film	5.6kΩ	K	SRD¼P
R717	1114464	carbon, film	2.7kΩ	J	SRD¼P	R 44	0114470	carbon, film	5.6kΩ	K	SRD¼P
R718	0138293	carbon, film	22Ω	J	SRD¼SD	R 45	0114468	carbon, film	3.9kΩ	K	SRD¼P
R801	1114465	carbon, film	2.2kΩ	K	SRD¼P	R 46	0114468	carbon, film	3.9kΩ	K	SRD¼P
R802	1114544	carbon, film	180kΩ	K	SRD¼P	R 47	0114471	carbon, film	6.8kΩ	K	SRD¼P
R803	1114541	carbon, film	100kΩ	K	SRD¼P	R 48	0114471	carbon, film	6.8kΩ	K	SRD¼P
						R 49	0114472	carbon, film	8.2kΩ	K	SRD¼P
						R 50	0114472	carbon, film	8.2kΩ	K	SRD¼P
						R 51	0114522	carbon, film	12kΩ	K	SRD¼P

SYMBOL NO.	STOCK NO.	DESCRIPTION	SYMBOL NO.	STOCK NO.	DESCRIPTION
R 52	0114522	carbon, film 12kΩ K SRD¼P	TR706	2327022	2SC 984 ⑥
R 53	0114526	carbon, film 27kΩ K SRD¼P	TR707	2320161	2SA 565 ⑥
R 54	0114526	carbon, film 27kΩ K SRD¼P			
R 55	0114526	carbon, film 27kΩ K SRD¼P	TR801	2320161	2SA 565 ⑥
R 56	0114526	carbon, film 27kΩ K SRD¼P	TR802	2320242	2SA 537A ⑥
R 57	0114522	carbon, film 12kΩ K SRD¼P	TR803	2320232	2SC 708A ⑥
R 58	0114522	carbon, film 12kΩ K SRD¼P	TR804	2327182	2SC 680 ⑥
R 59	0114472	carbon, film 8.2kΩ K SRD¼P	TR805	2327192	2SA 566 ⑥
R 60	0114472	carbon, film 8.2kΩ K SRD¼P	TR806	2327022	2SC 984 ⑥
R 61	0114471	carbon, film 6.8kΩ K SRD¼P	TR807	2320161	2SA 565 ⑥
R 62	0114471	carbon, film 6.8kΩ K SRD¼P			
			for DC POWER SOURCE CIRCUIT BOARD		
R 64	0114463	carbon, film 1.5kΩ K SRD¼P	TR902	2320232	2SC 708A ⑥
R 65	0114463	carbon, film 1.5kΩ K SRD¼P	TR903	2320161	2SA 565 ⑥
R 66	0114542	carbon, film 120Ω K SRD¼P			
R 67	0114542	carbon, film 120Ω K SRD¼P	for CHASSIS ASSEMBLY		
R 69	0114529	carbon, film 47kΩ K SRD¼P	TR 1	2327172	2SC 897 ⑥
R 70	0114529	carbon, film 47kΩ K SRD¼P	TR 2	2327172	2SC 897 ⑥
R 73	0114532	carbon, film 82kΩ K SRD¼P	TR 3	2327172	2SC 897 ⑥
R 74	0114532	carbon, film 82kΩ K SRD¼P	TR 4	2327172	2SC 897 ⑥
R 75	0131844	composition 1MΩ K RC¼GF			
R 76	0131844	composition 1MΩ K RC¼GF			
R 77	0114443	carbon, film 150Ω K SRD¼P			
R 78	0114443	carbon, film 150Ω K SRD¼P			
R 79	0134375	composition 1.5kΩ K RC½GF			
R 80	0134375	composition 1.5kΩ K RC½GF			
R 81	0134361	composition 100Ω K RC½GF			
	0114521	carbon, film 10kΩ K SRD¼P			
TRANSISTORS					
for MC CIRCUIT BOARD					
TR101	2320073	2SC 458LG ③			
TR102	2320073	2SC 458LG ③			
for EQUALIZER CIRCUIT BOARD					
IC201	2327302	FA - 6001T			
IC202	2327302	FA - 6001T			
for MIC AMPLIFIER CIRCUIT BOARD					
TR301	2320073	2SC 458LG ③			
TR302	2320073	2SC 458LG ③			
TR303	2320073	2SC 458LG ③			
TR304	2320073	2SC 458LG ③			
for VU METER AMPLIFIER CIRCUIT BOARD					
TR501	2320073	2SC 458LG ③			
TR502	2320073	2SC 458LG ③			
for PRE-AMPLIFIER CIRCUIT BOARD					
TR601	2327122	2SC 458ALG ③			
TR602	2327122	2SC 458ALG ③			
TR603	2320073	2SC 458LG ③			
TR604	2320073	2SC 458LG ③			
TR605	2320073	2SC 458LG ③			
TR606	2320073	2SC 458LG ③			
TR607	2320073	2SC 458LG ③			
TR608	2320073	2SC 458LG ③			
for MAIN AMPLIFIER CIRCUIT BOARD					
TR701	2320161	2SA 565 ⑥			
TR702	2320242	2SA 537A ⑥			
TR703	2320232	2SC 708A ⑥			
TR704	2327182	2SC 680 ⑥			
TR705	2327192	2SA 566 ⑥			
DIODES					
for VU METER AMPLIFIER CIRCUIT BOARD					
D501	0575019	IN60P			
D502	0575019	IN60P			
D503	0575019	IN60P			
D504	0575019	IN60P			
for MAIN AMPLIFIER CIRCUIT BOARD					
D701	2327041	V06C			
D702	2327041	V06C			
D703	2327041	V06C			
D704	2327041	V06C			
D801	2327041	V06C			
D802	2327041	V06C			
D803	2327041	V06C			
D804	2327041	V06C			
for DC POWER SOURCE CIRCUIT BOARD					
D903	0575050	V01G			
D904	0575050	V01G			
D905	0575050	V01G			
D906	0575050	V01G			
D907	2327073	AW01-24			
D908	2327073	AW01-24			
for CHASSIS ASSEMBLY					
D 1	2327041	V06C			
D 2	2327041	V06C			
D 3	2327041	V06C			
D 4	2327041	V06C			
VARIABLE RESISTORS					
VR 1	0156127	Balance			100kΩ-HB
VR 2	0156126	Volume			100kΩ-B
VR 3	0153232	MIC level			100kΩ-B
VR 4	0151202	VU meter balance			200Ω-B
VR701	0152518	Adjust main amp. center voltage			20kΩ-B
VR702	0152517	Adjust main amp. idle current			200Ω-B
VR801	0152518	Adjust main amp. center voltage			20kΩ-B
VR802	0152517	Adjust main amp. idle current			200Ω-B

SYMBOL NO.	STOCK NO.	DESCRIPTION	SYMBOL NO.	STOCK NO.	DESCRIPTION
MISCELLANEOUS					
	2518171	MC circuit board assembly		2680482	T-tipe mold 5 pin terminal board
	2518222	Equalizer circuit board assembly		2650113	Socket-transistor socket
	2518161	MIC amplifier circuit board assembly		0544404	6 pin terminal board
	2518151	VU meter amplifier circuit board assembly		0544402	2 pin terminal board
	2518291	Pre-amplifier circuit board assembly		0544384	4 pin terminal board
	2518531	Main amplifier circuit board assembly		0541358	Socket - 5pin socket (DIN terminal)
	2518241	DC power source circuit board assembly		4725312	Label (for AC 220V, 50/60 Hz)
	2518331	DIN circuit board assembly		4725571	Label (for AC 1.5A)
	2518181	Sub assembly circuit board assembly		4725561	Label (for AC 1.5A, 250V)
	4784571	Screw-3 x 6φ baird screw (for radiation fin fixing and circuit board weight, etc.)	SW 1	4725551	Label (for cover words)
	4784101	Screw-3 x 8φ baird tapping screw (for chassis parts fixing, etc.)		2577024	VU meter (1.2kΩ, 130mA)
	4562401	Screw-earth screw		2637141	Switch-lever switch (AC power source, speaker change-over)
	4770255	Nut-4φ nut with washer (for transformer fixing)	SW 2	0532183	Switch-slide switch(Input sensitivity MC/MM)
	0043793	Bushing (nylon)	SW 3	2617191	Switch-rotary switch (Function)
	2740241	Cord-AC cord (UL)	SW 4	2637061	Switch-lever switch (Tape monitor)
	2747301	Cord-AC cord with SAA standard 3 pin plug	SW 5	2617232	Switch-rotary switch (Mode)
	2657051	Socket - AC socket	SW 6-8	2637061	Switch-lever switch (Mute, Loudness, Hi-filter)
	2217272	Transformer-power transformer	SW 9-10	2617181	Switch-rotary switch (Tone)
	2727134	Fuse-fuse (AC 250V, 1.5A) SLOW (for 220, 240V set)	SW 11	2637061	Switch-lever switch (Low filter)
	2727012	Fuse-fuse (AC 125V, 3A) SLOW (for 120V set)	SW 12	2627011	Switch-slide switch (Pre-Main connection)
	2720033	Fuse-fuse (DC 100V, 3A) FAST	SW13-14	2637141	Switch-lever switch (AC power source, speaker change-over)
	2727086	Fuse-wired in fuse (AC125V, 4A) SLOW (for 120V set)	SW 15	0153232	Variable resistor (with switch, MIC level)
	2727062	Holder-fuse holder	SW 16	2617071	Switch-rotary switch (VU change-over)
	2677101	Jack-microphone jack	for FINAL ASSEMBLY		
	2687141	4 pin terminal board		3240941	Escutcheon assembly
J 1, 2	2677063	Jack-headphone jack		3914141	Knob-inside knob (function)
	2687151	Pin jack - 6P US pin jack		3914131	Knob-inside knob (volume)
	2670221	Pin jack - 4P US pin jack		4564651	Knob-volume knob assembly
	2687161	Pin jack - 1P US pin jack		4564661	Knob-function knob assembly
PL 1-5	2767115	Lamp-pilot lamp (6.3V, 70mA)		3280702	Switch-lever switch
PL 6-7	2760051	Lamp-pilot lamp (6.3V, 150mA)		4358772	Cover assembly
	2720022	Holder-fuse holder (for pilot lamp socket)		4924021	Side board assembly (left)
	2657121	Plug-voltage change-over connector plug (for 220, 240V set)		4924011	Side board assembly (right)
	2787143	Connector-22 pin circuit board connector		4564272	Screw-M4 baird screw (for side board and cover fixing)
	2787141	Connector-12 pin circuit board connector		4680751	Leg

MODEL IA-1000 SERVICE MANUAL



Head Office : 5-1, 1-chome, Marunouchi, Chiyoda-ku, Tokyo
Tel. : Tokyo (212) 1111 (80 lines)
Cable Address: "HITACHY" TOKYO
Codes : All Codes Used

Printed in Japan (H)